



BEAL

GB









<b>Work restraint, work position, fall arrest, suspension</b> .....	<b>4-5</b>
<b>Notions of falling for work at height</b> .....	<b>6-7</b>
<b>Anchor, breaking load &amp; rope protectors</b> .....	<b>8-9</b>
<b>Verticality</b> .....	<b>10-21</b>
Work restraint .....	10-11
Short-term work on roof .....	12-13
Fall arrest & work positioning .....	14-15
Suspension : access the workstation .....	16-17
Suspension : descent & work .....	18-19
Work in specific environments .....	20-21
<b>Performances chart</b> .....	<b>22-30</b>
Ropes .....	22-23
Webbing, flat slings, anchor .....	24
Lanyard .....	25
Harness .....	26-27
Helmet .....	27
Connector .....	28
Quick links, rigging plates and swivel, pulleys .....	29
Descenders, fall arrest, rope clamps .....	30
<b>Equipment</b> .....	<b>31-55</b>
Ropes for difficult area access .....	31-32
Floating rope & rope for difficult area access .....	32
Dynamic ropes .....	32
Rescue ropes .....	33
Ropes resistant to high temperatures .....	33
Ropes resistant to chemical products .....	34
Special ropes .....	34
Ropes for tree work .....	35
Ropes for prusiks .....	35
Accessory cords .....	36
Webbing .....	36
Flat slings .....	36
Anchors .....	37
Adjustable lanyards .....	37
Not adjustable lanyards .....	38
Fall arrest lanyards .....	39
Fall arrest harness .....	40
Workstation belt .....	40
Fall arrest, rope access and work positioning harness .....	41-43
Rescue harness .....	44
Harness accessories .....	44
Helmet .....	45
Locking connector .....	46
Quick links .....	47
Pulleys .....	47
Rigging plates and swivel .....	47
Descenders & fall arrest .....	48-49
Rope clamps .....	50
Bags .....	51
Work station .....	52-53
Kits .....	54
Rope protector .....	54
Accessories .....	55



## WORK RESTRAINT

---

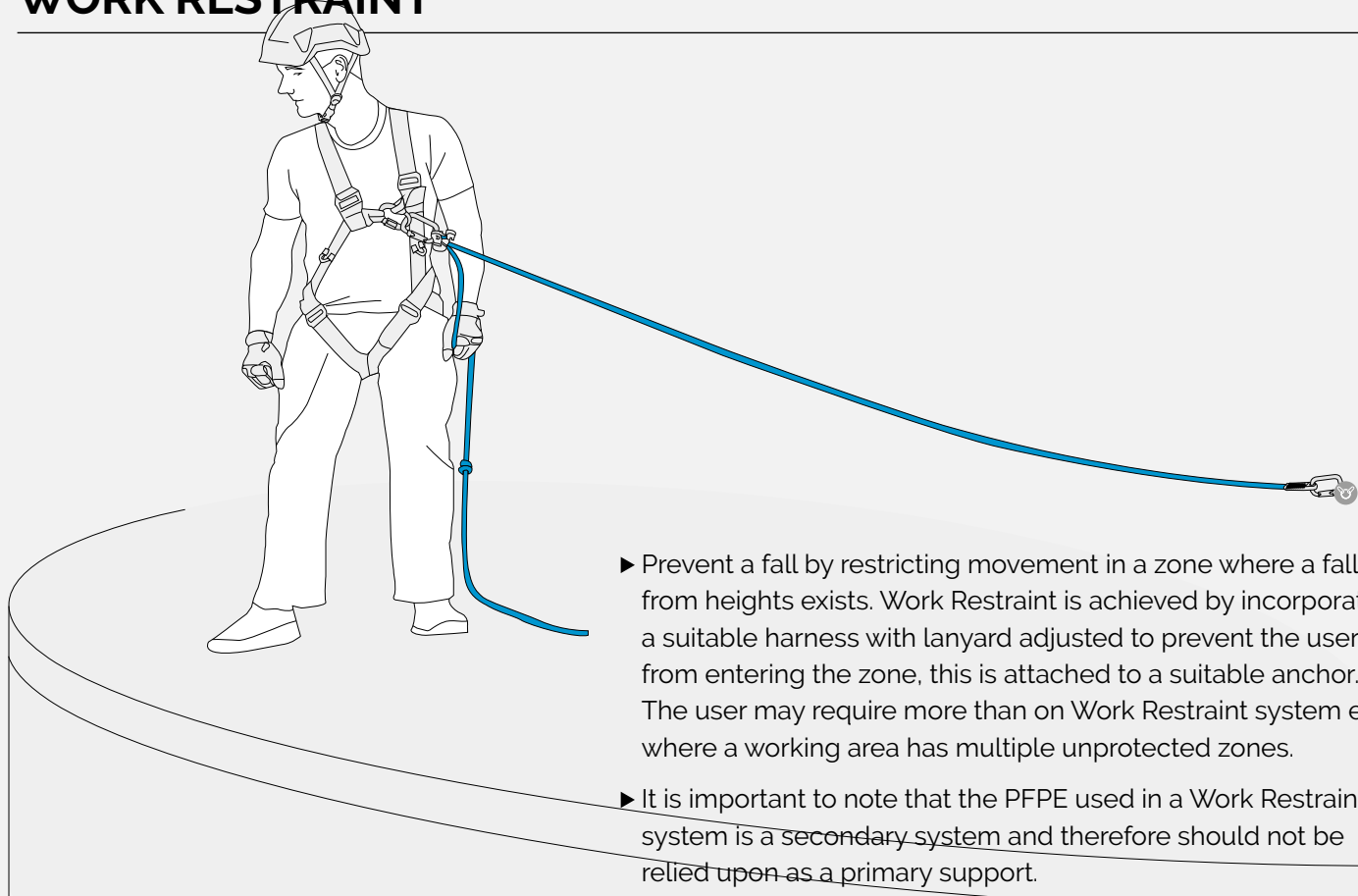

## WORK POSITION

---

- ▶ Allows a user to be supported at work station.
- ▶ The system must be attached to a suitable anchor.
- ▶ The user is standing on his feet and the system always under tension.
- ▶ A fall arrest system must be added to the work positioning system.

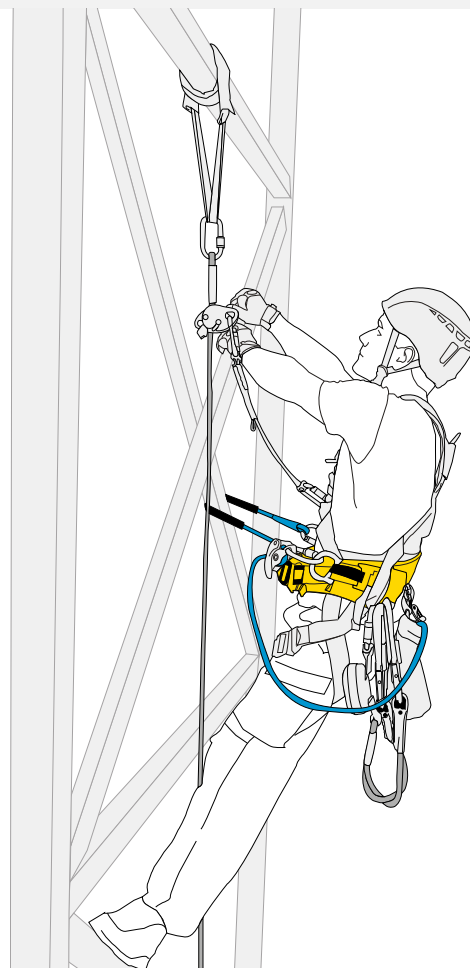



## FALL ARREST

- ▶ Allows a user to enter a zone where a fall from height exists. This is achieved by incorporating a Fall Arrest harness with energy absorbing lanyard which is connected to a suitable anchor limiting the impact force generated during a freefall.
- ▶ It is important to note that the PFPE used in a fall arrest system is a secondary system and therefore should not be relied upon as a primary support.

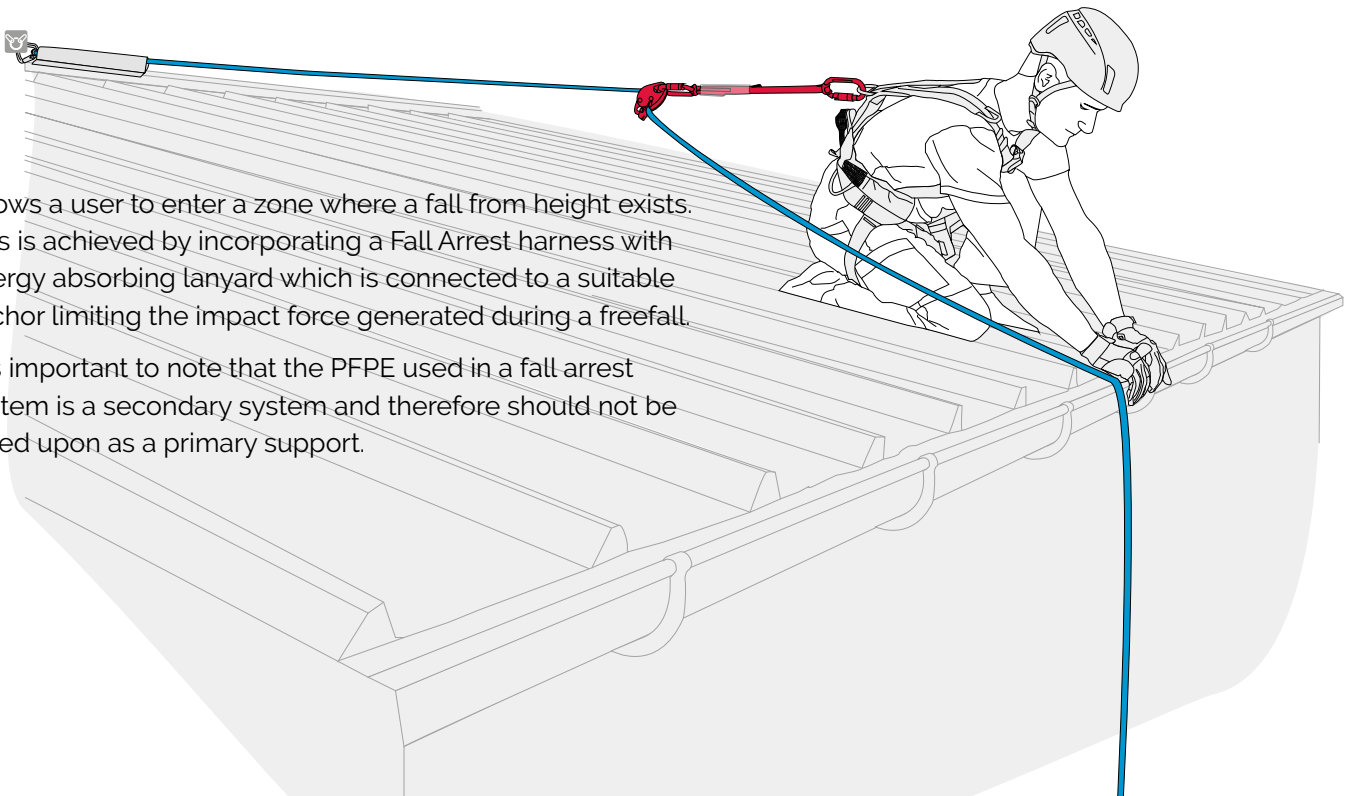

## SUSPENSION

- ▶ When the user is not anymore standing on his feet, the harness he is suspending in, has to comply with 3 standards : work positioning (EN 358), fall Arrest (EN 361) and suspension (EN 813).

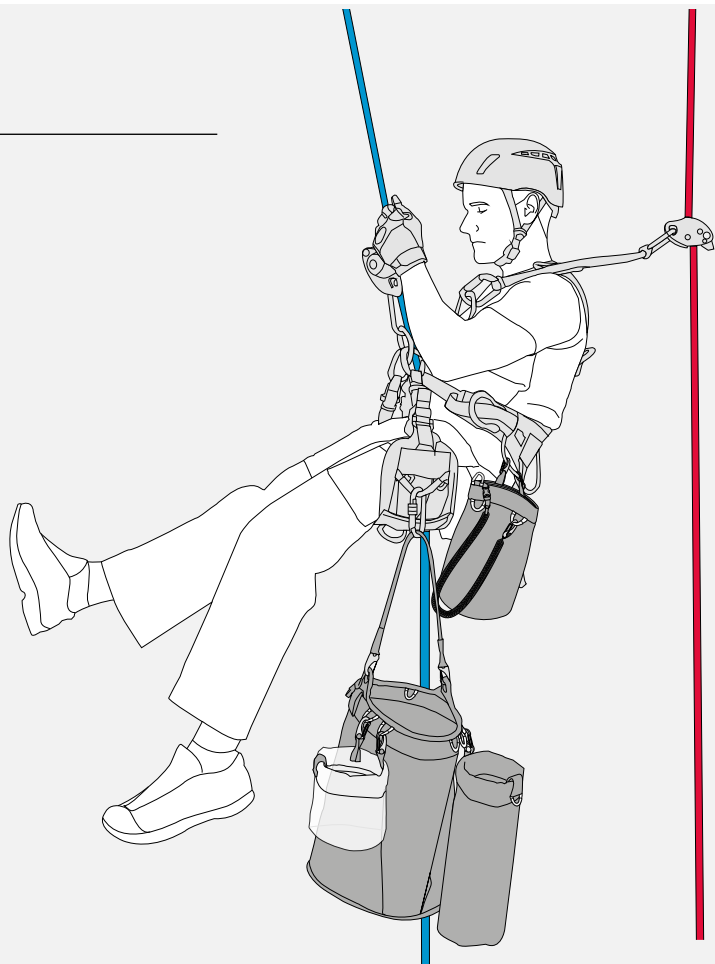



# NOTIONS OF FALLING FOR WORK AT HEIGHT

## The height of the fall :

The longer the fall distance, the greater the energy to dissipate to avoid too violent a shock.

## The height of the anchorage :

The operator should always avoid climbing above the anchor point in order to limit the fall factor.

## The weight of the operator with their equipment :

The larger the mass, the greater the energy to be absorbed.

## FALL FACTOR

Some examples with 100kg and lanyard without energy absorber.

### ZERO FALL FACTOR

The lifeline is located 1 metre above the attachment point.

$$\frac{0 \text{ m fall}}{1 \text{ m lanyard}} = \text{factor } 0$$

Impact Force < 6kN

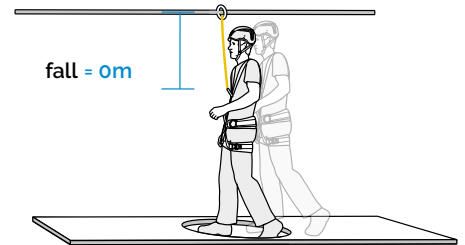
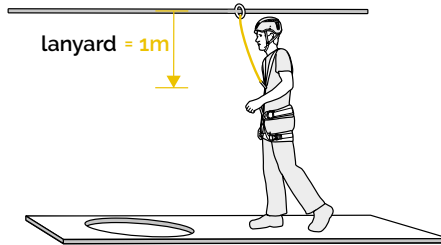

### DANGER FALL FACTOR

The lifeline is located at the point of attachment.

$$\frac{1 \text{ m fall}}{1 \text{ m lanyard}} = \text{factor } 1$$

Impact Force > 6kN

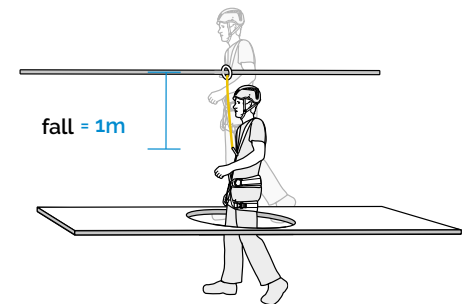
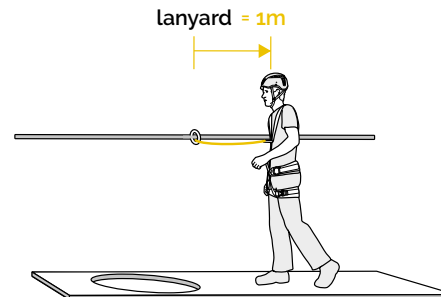

### CRITICAL FALL FACTOR

The lifeline is located 1 metre below the attachment point.

$$\frac{2 \text{ m fall}}{1 \text{ m lanyard}} = \text{factor } 2$$

Impact Force > 6kN

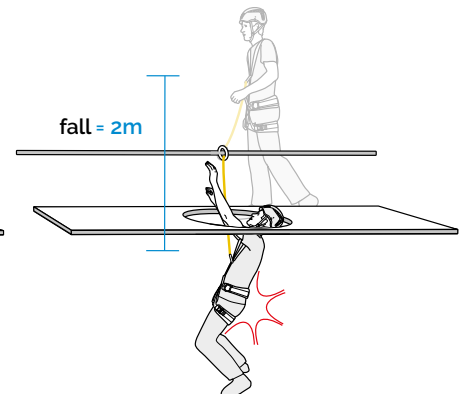
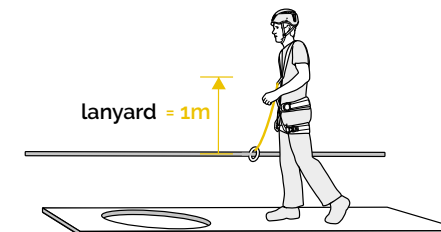

**The impact force :**

This is the impact suffered by the operator once the anti-fall system has absorbed some of the energy from the fall. In high-level work, the anti-fall system (energy absorber, mobile fall control, etc.) limits the impact force to 6kN for a mass of 100kg.

Any system other than that of anti-fall, does not absorb enough energy from a fall, whatever the factor (e.g. lanyard for restraint).

**GROUND CLEARANCE**

Some examples with 100kg and lanyard with an energy absorber.

**CALCULATING GROUND CLEARANCE**

The ground clearance is the space needed under the feet of the worker so that they do not encounter the ground during a fall.

Even with a fall control system you can put yourself in danger during a fall.

During a fall, the absorber will deploy to dissipate the energy, if the worker does not provide sufficient distance with an obstacle located below them, they will endanger themselves.

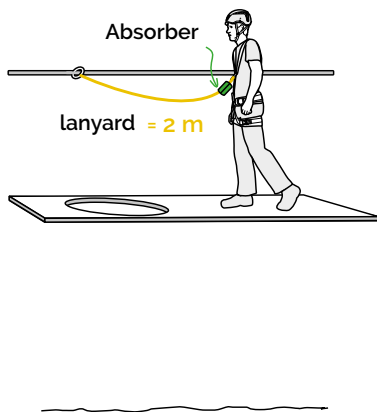

Ground Clearance = 5,90 m

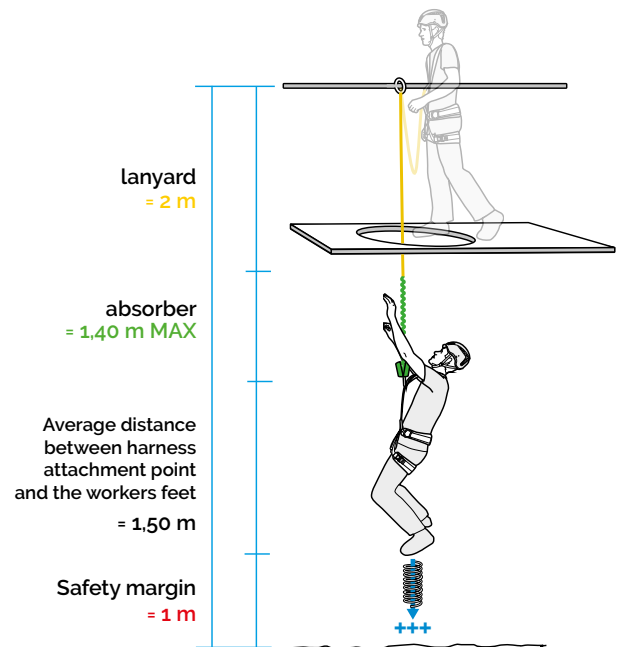

**WARNING IN CASE OF AN OBSTACLE**

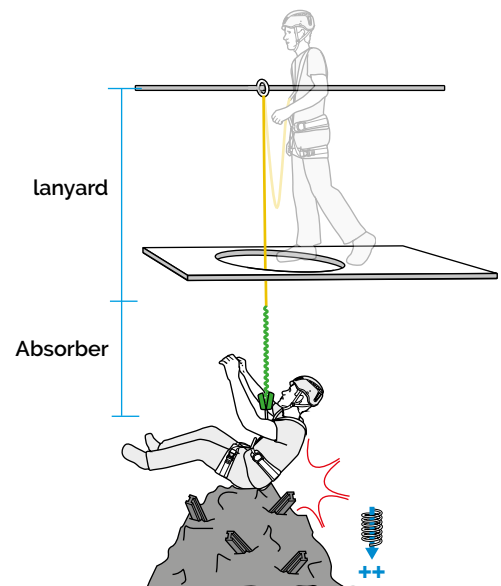
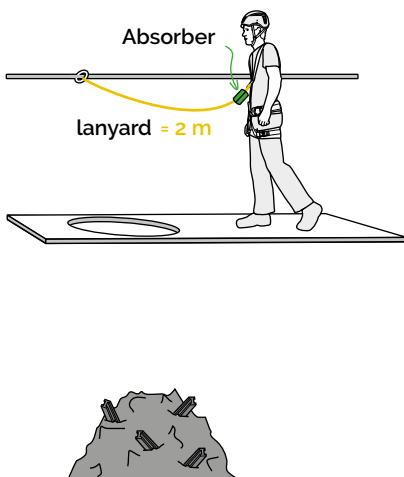



## ANCHOR DEVICE CONFIGURATION

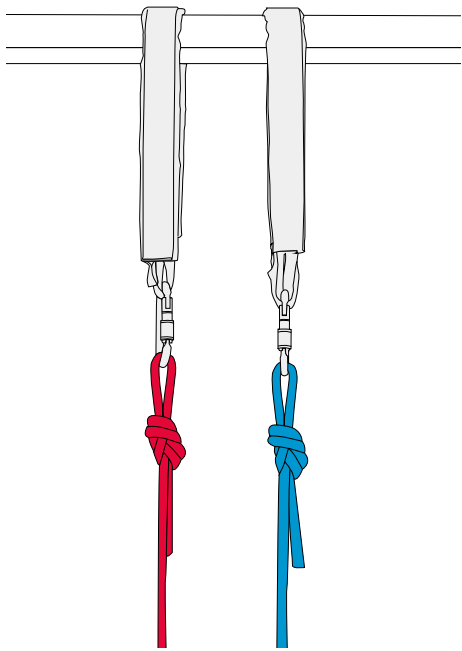

Basic anchor

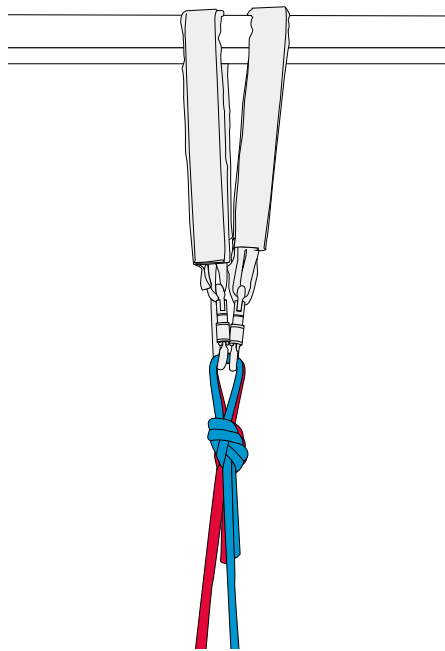

Symmetrical anchors shared for added security

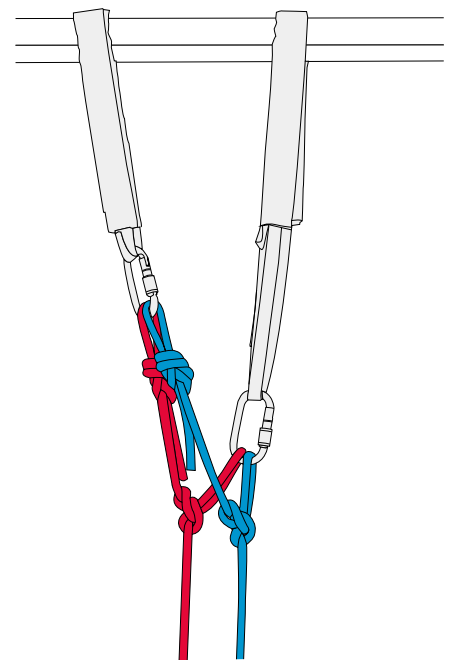

Assymetrical anchors shared for added security

## BREAKING LOAD, SLING 18 mm : 22 kN

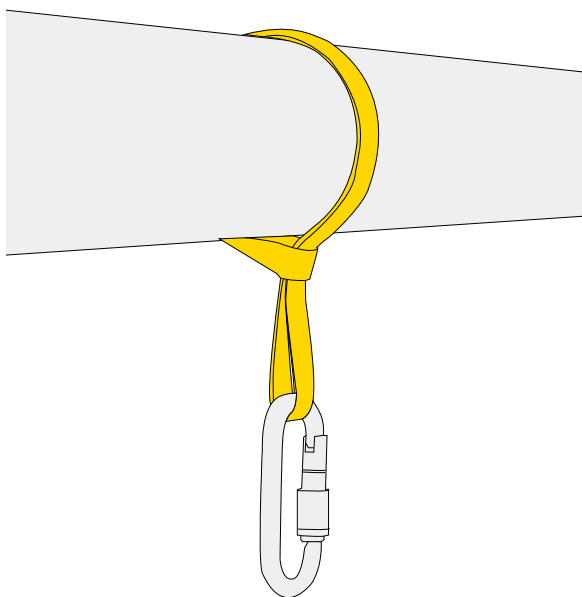

18 kN

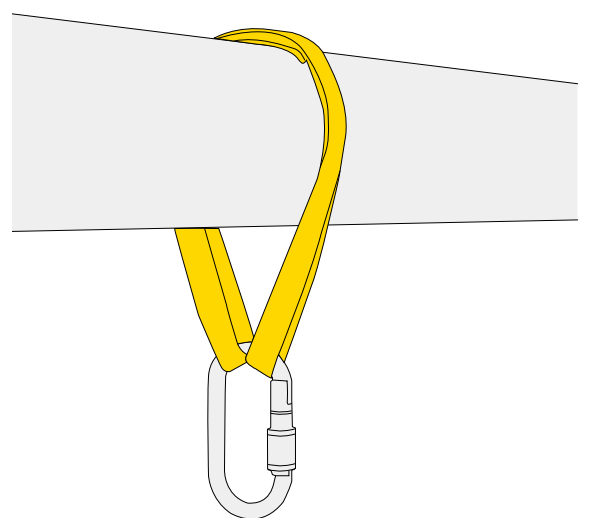

30 kN

# ROPE PROTECTORS

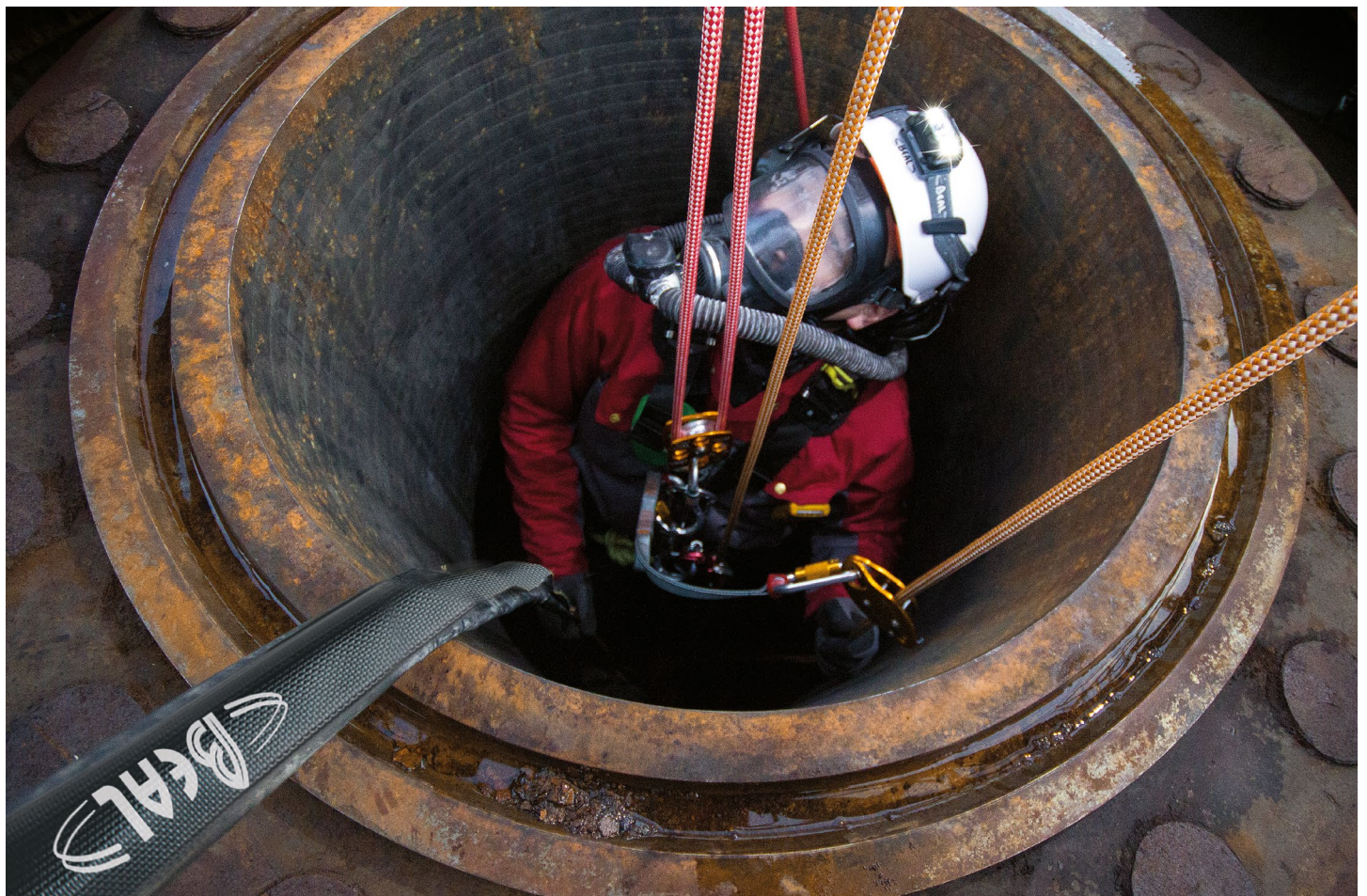
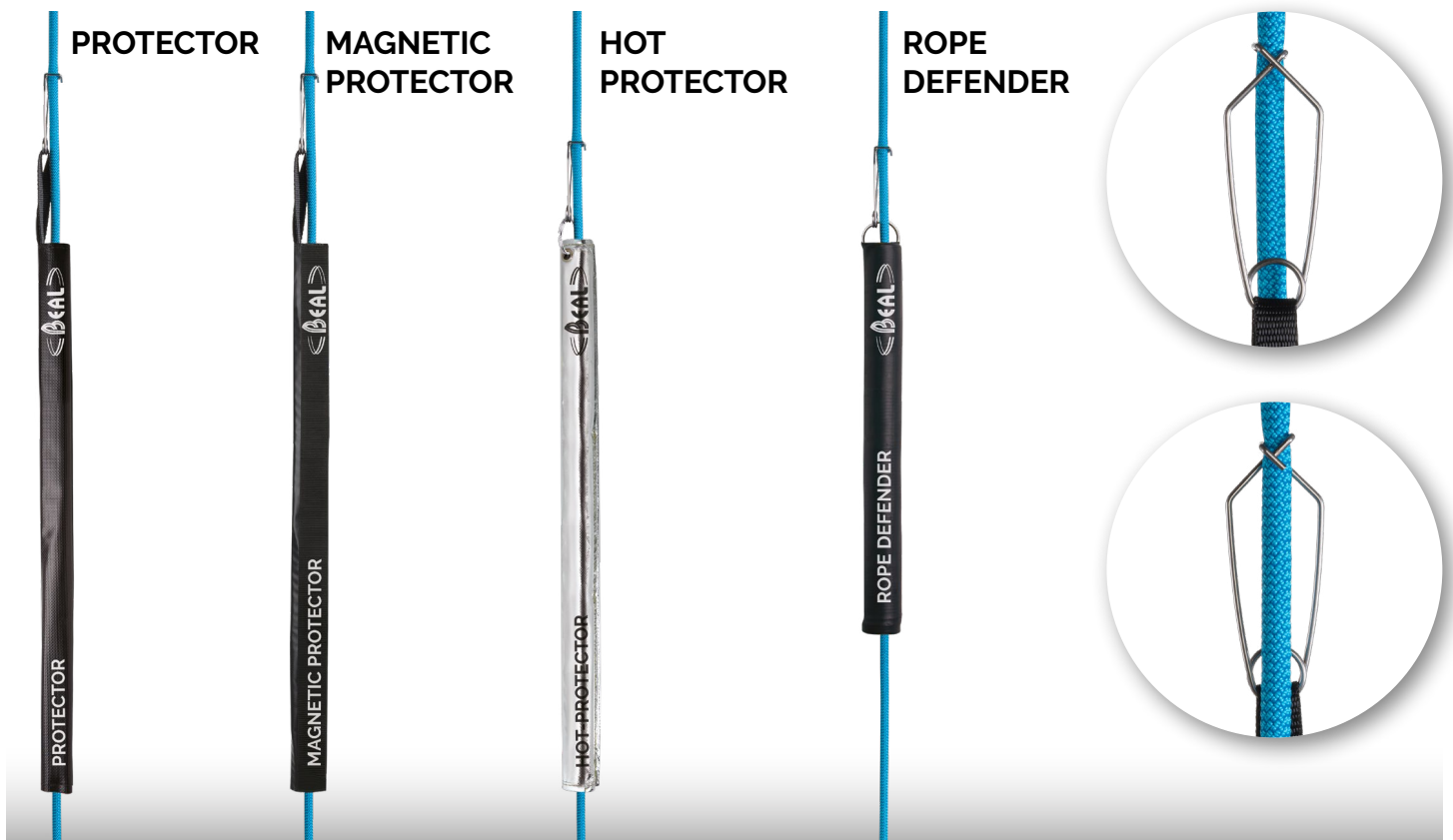



## NOT ADJUSTABLE WORK RESTRAINT

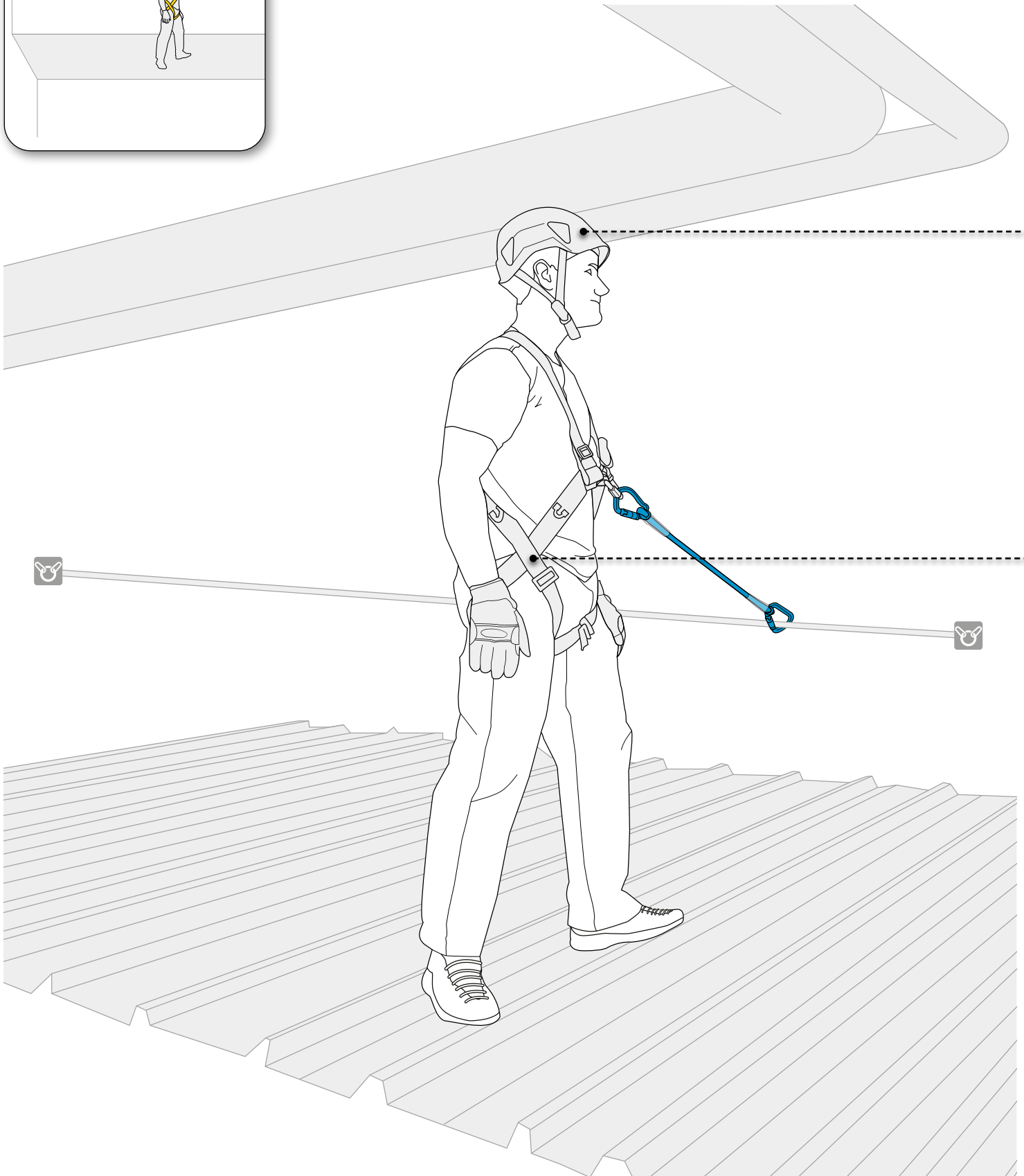
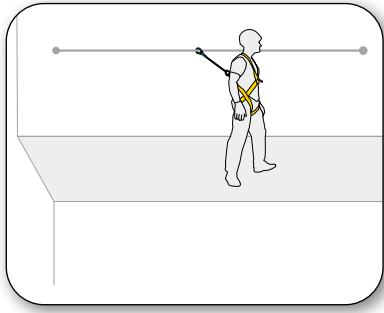

## QUANTUM p 52

Light helmet featuring an ABS shell with a polystyrene liner for optimal energy absorption in case of impact. Its chinstrap opens between 15 and 25 daN in order to avoid strangulation. Certified EN 397.



## STYX RESCUE p 47

Lightweight and compact fall arrest harness with two attachment points: 1 sternal and 1 dorsal.

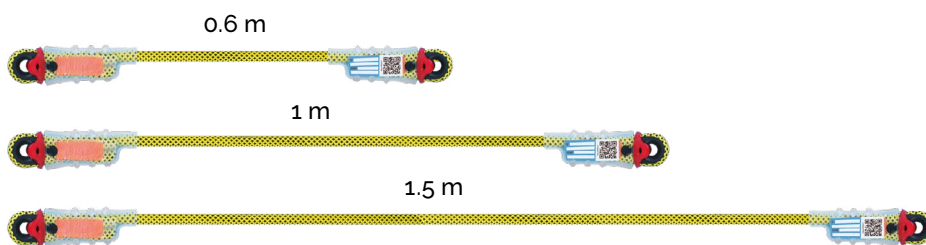
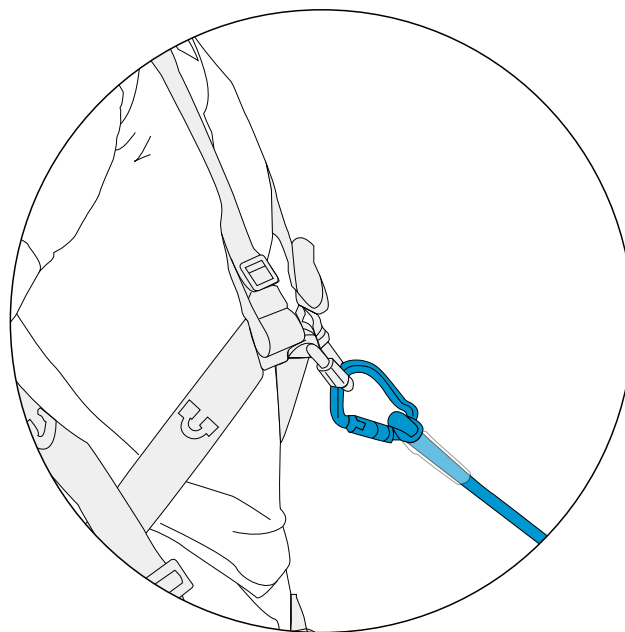

## DYNAPRO p 45

Simple dynamic rope lanyard with sewn termination for work restraint. The dynamic characteristics of this lanyard are far superior to those of a traditional static lanyard.



# SHORT-TERM WORK ON ROOF

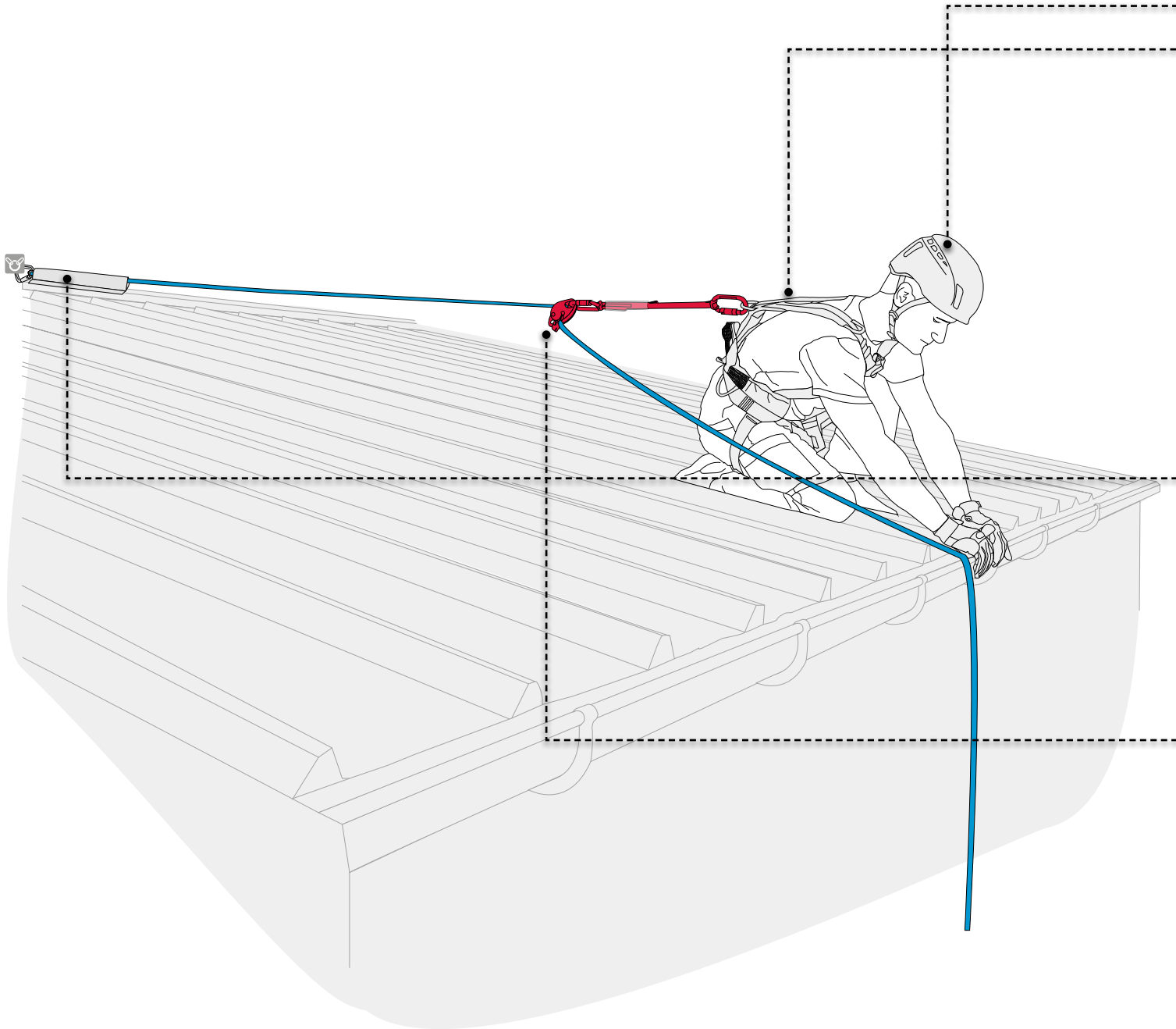
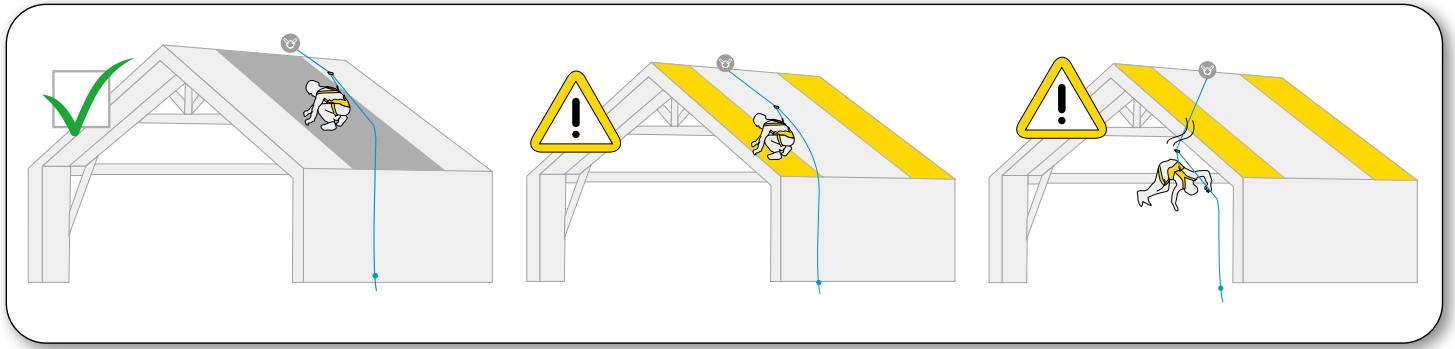

## QUANTUM p 53

Light helmet featuring an ABS shell with a polystyrene liner for optimal energy absorption in case of impact. Its chinstrap opens between 15 and 25 daN in order to avoid strangulation. Certified EN 397.



## STYX FAST p 47

A very light and compact fall arrest harness with 2 connection points : 1 sternal and 1 dorsal. Quick release buckles to the thighs and a foamed back allow a quick sitting. Versatile because it can be combined with a work position belt.

### FAST BUCKLE HOOK BEAL



SET UP :  
Lock 2 actions

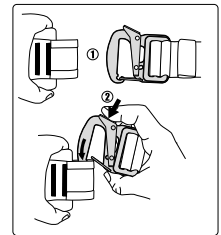

SET UP :  
open 3 actions

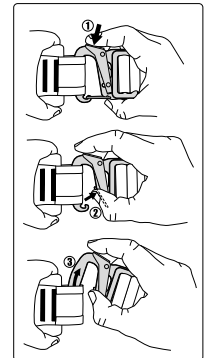

## PROTECTOR p 62

A rope can wear very rapidly over a sharp edge. To protect it, use the PROTECTOR, an ultra-solid rope protector made of two layers of coated material.



0.7 m



## AIR-KIT 11 mm p 57

Specific kit to create a mobile fall arrest system especially adapted to vertical work or work on inclined surfaces.

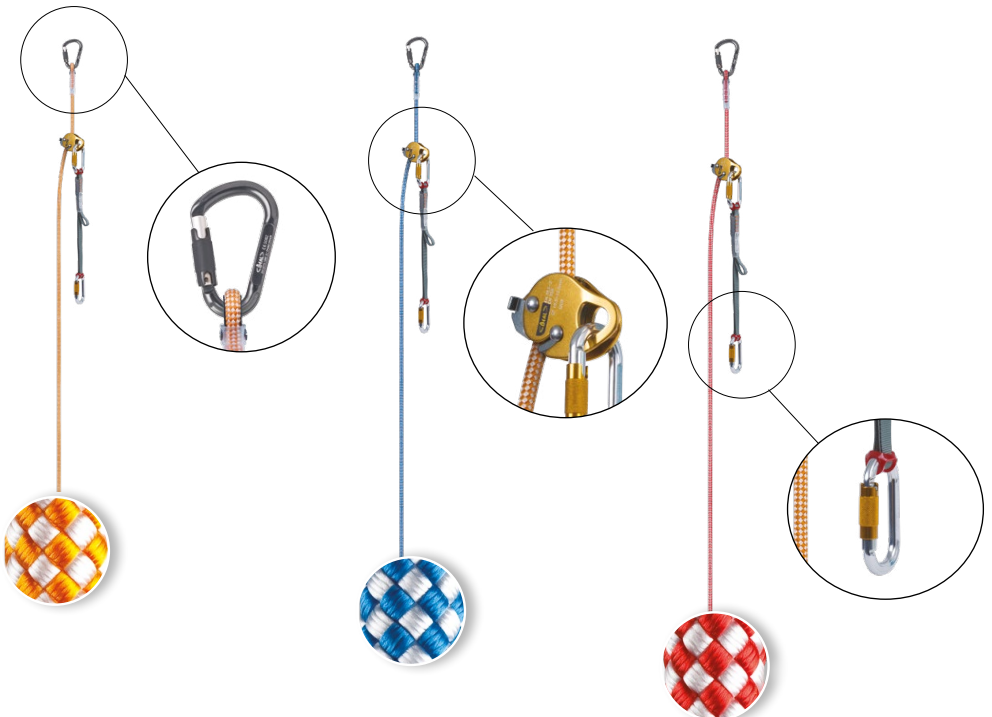
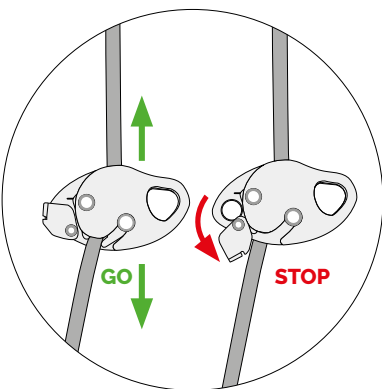



# FALL ARREST & WORK POSITIONING

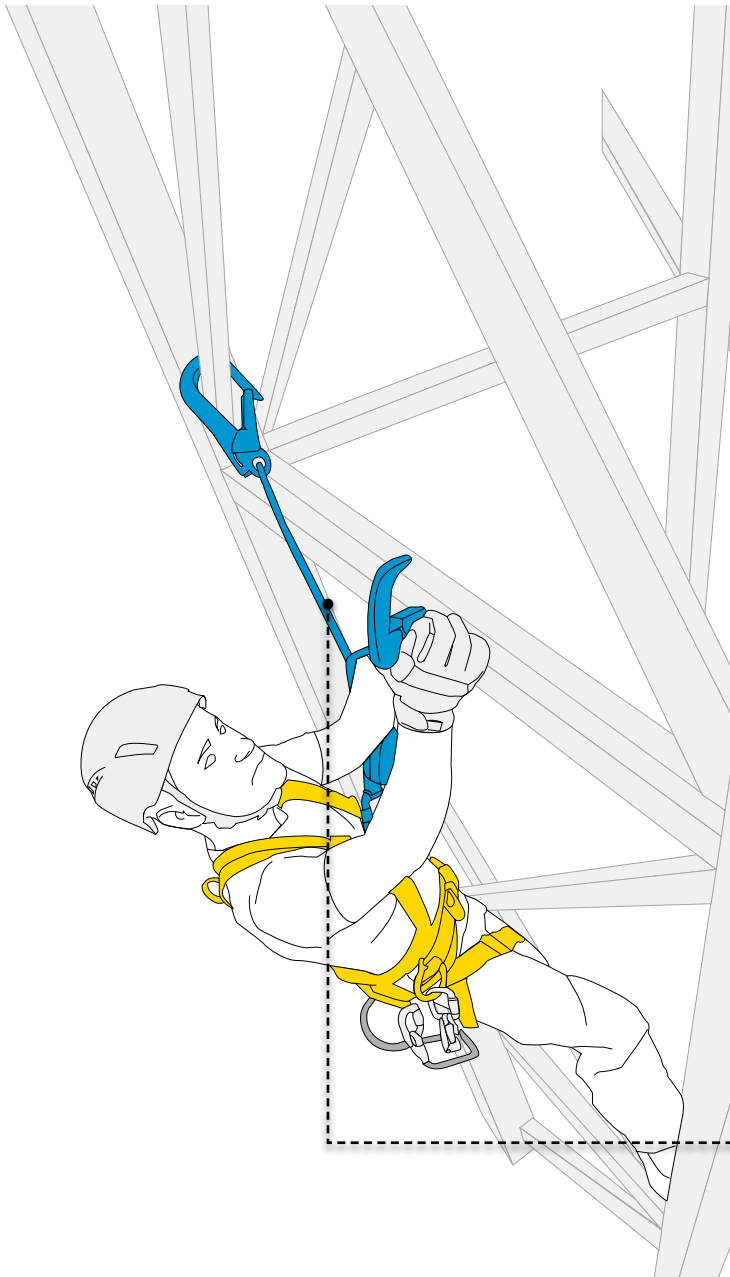
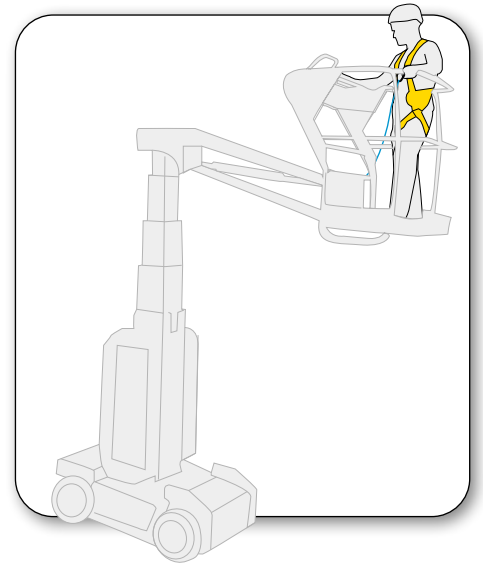
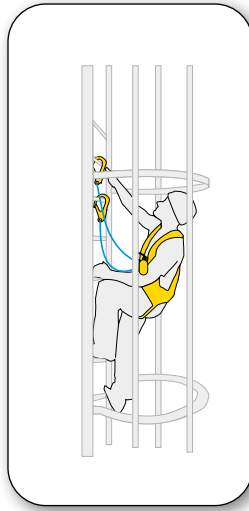
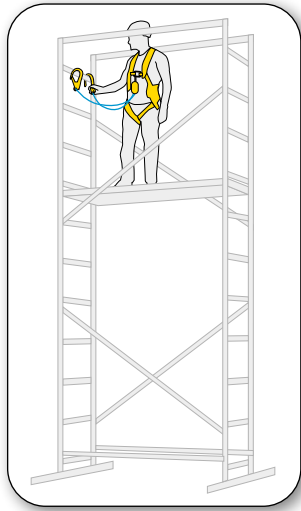
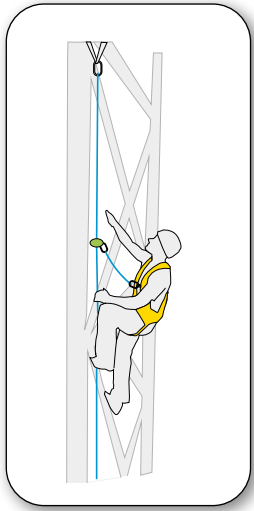

**CLIMBING**

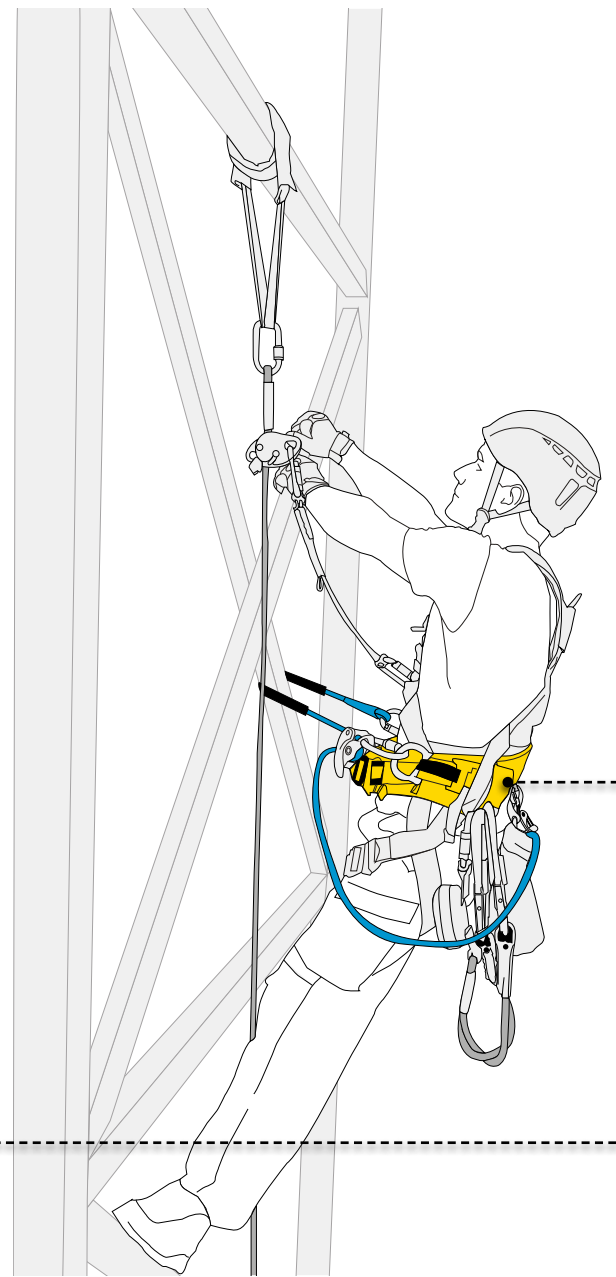

**WORK POSITIONING**

## STYX FAST p 47

A very light and compact fall arrest harness with 2 connection points : 1 sternal and 1 dorsal. Quick release buckles to the thighs and a foamed back allow a quick sitting. Versatile because it can be combined with a work position belt.



## STYX BELT p 47

Workstation belt. This adjustable belt makes it possible to adjust positioning rings to all morphologies or all situations by a simple sliding. The quick-release buckle offers a simple opening / closing. The belt is compatible with the STYX FAST harness.



## DYNAPRO-AIR V HOOK p 46

V-shaped fall arrest lanyard with integrated energy absorber (EN355 + EN362). Designed as a progression lanyard for work environments with a fall risk, it is well adapted to structures where anchor points are cables, bars or beams.

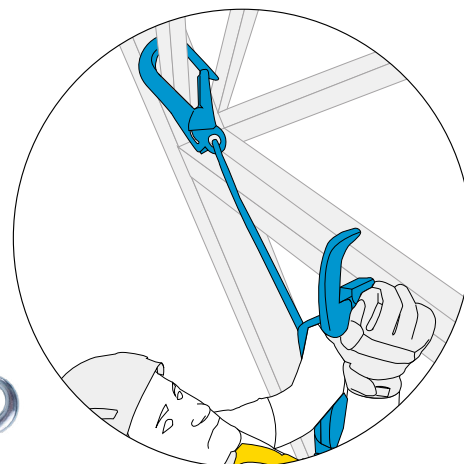
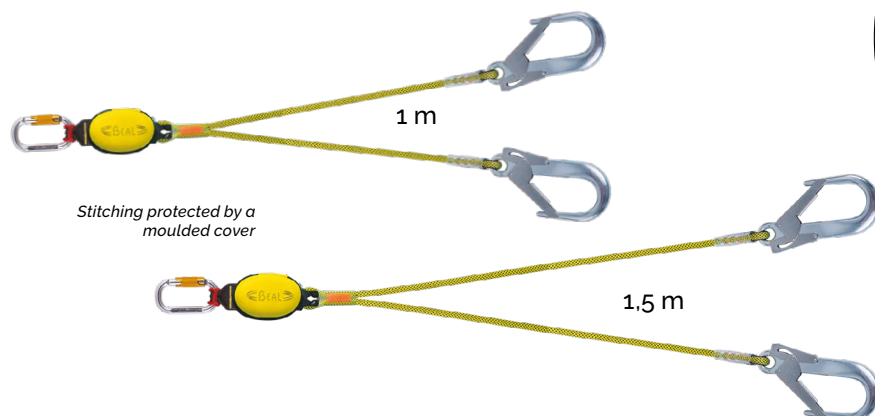

## DYNAPRO-AIR V HOOK XL p 46

V-shaped fall arrest lanyard with integrated energy absorber (EN355 + EN 362). Designed as a progression lanyard for work environments with a fall risk, the size of its connectors make it particularly suited to metal structures.

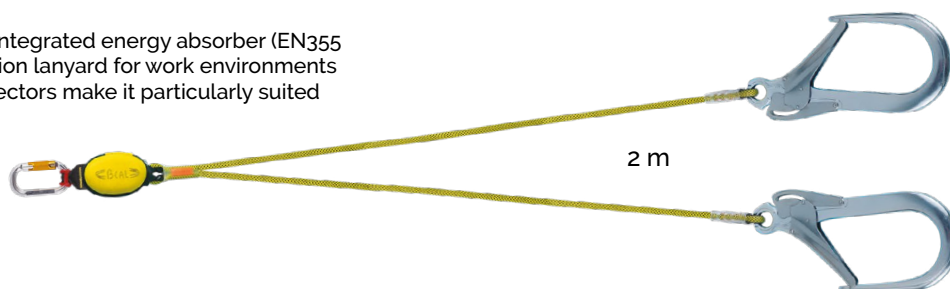

# SUSPENSION : ACCESS TO THE WORKSTATION

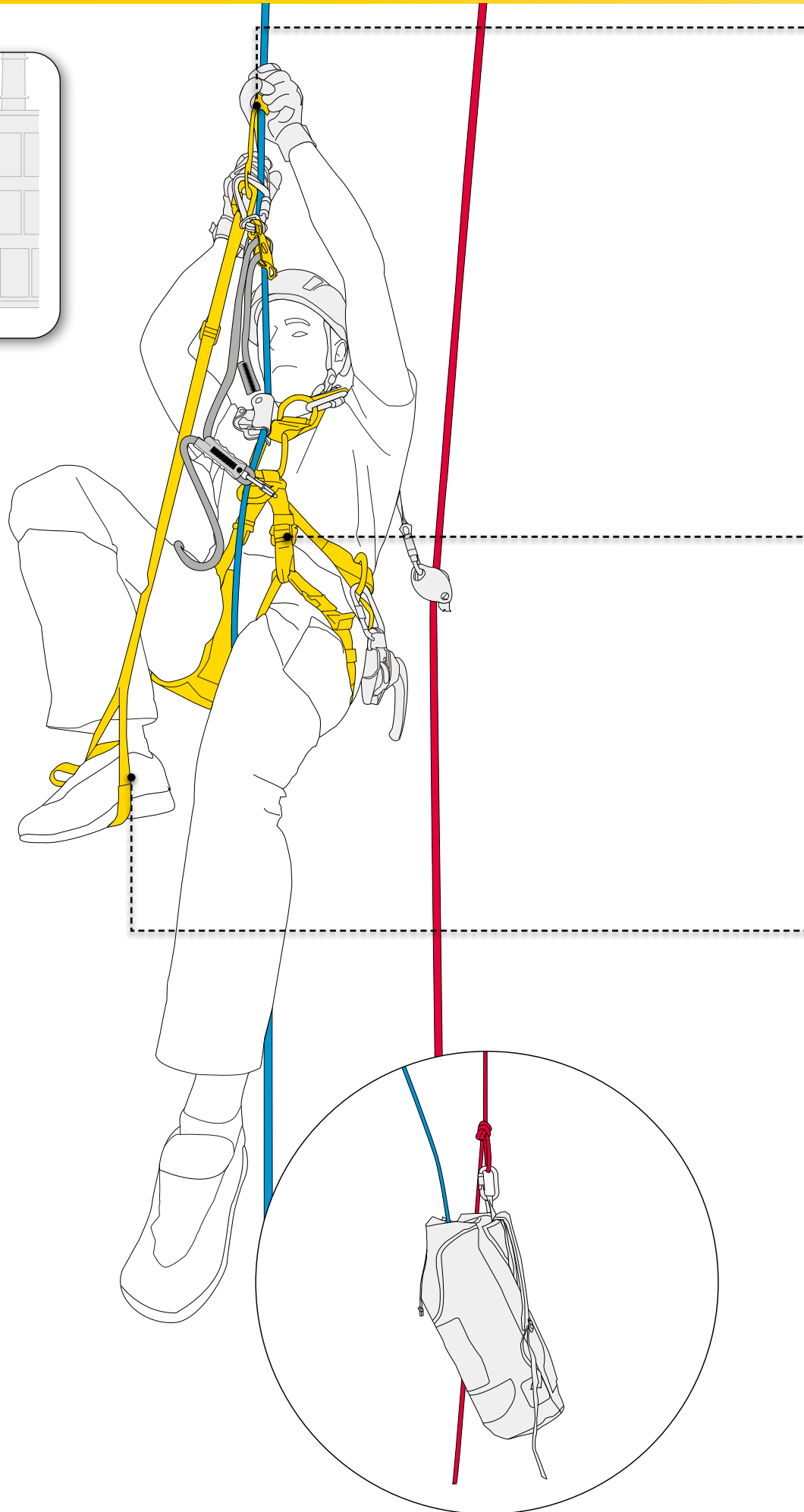
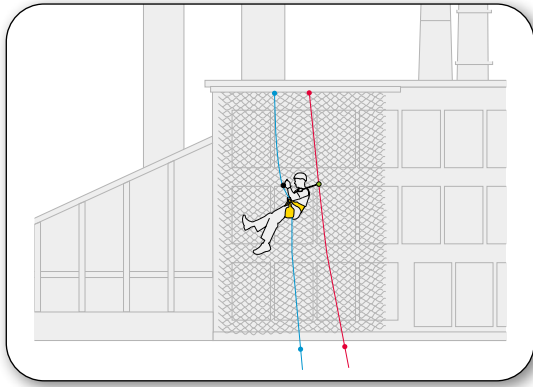



## SOLACE HOLD UP p 48



Harness for work positioning, suspension and fall arrest perfectly configured for rope access. Very effective at ascending ropes thanks to the low position of the HOLD UP and its parallel orientation to the body.

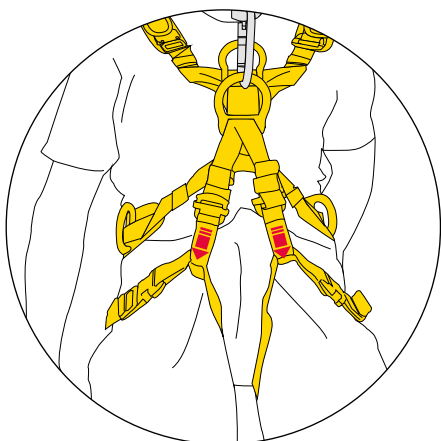

## HANDS UP p 58

Handled ascender with ergonomic design to aid rope ascents with one or two hands.

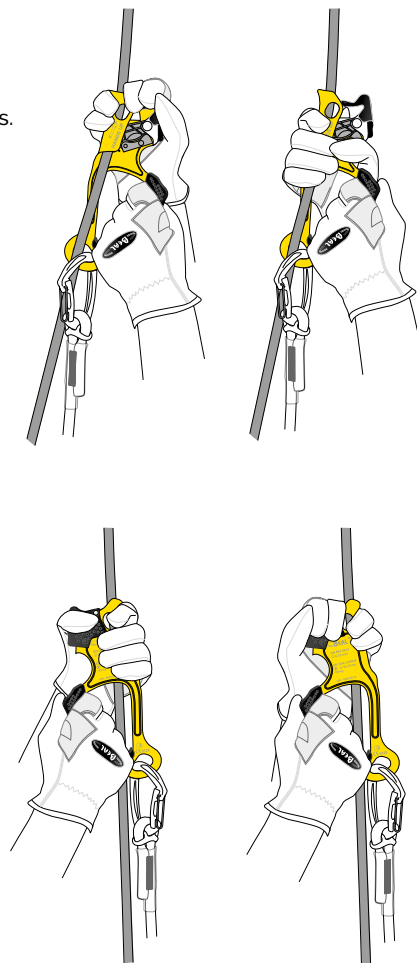

## ACCESS 11 mm p 34

With UNICORE as standard, bonding core and sheath for maximum security in all situations.



## INDUSTRIE 10,5 mm p 34

This rope is specially adapted to the requirements of work at height companies.



## AIR-STEP p 58

Adjustable footloop with quick adjusting system around the foot for ascending fixed ropes with an ascender.

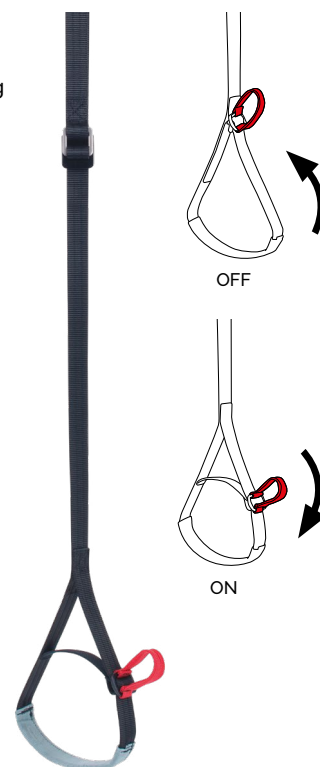
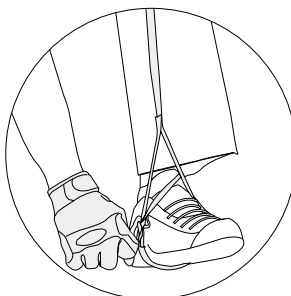
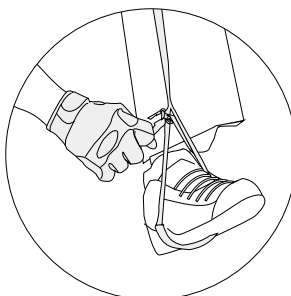

# SUSPENSION : DESCENT & WORK

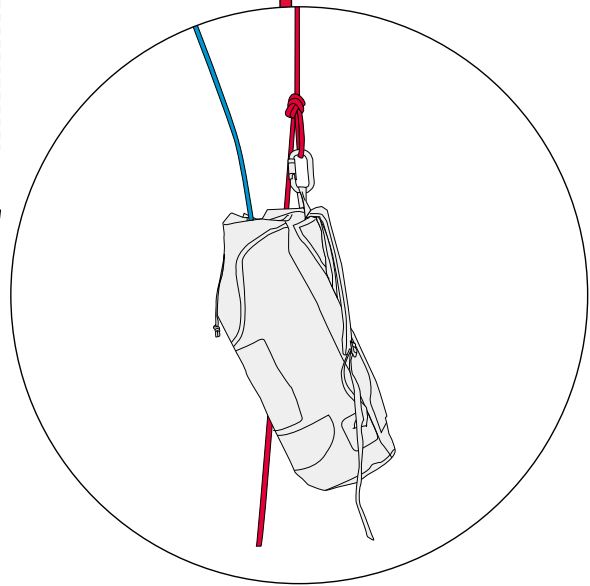
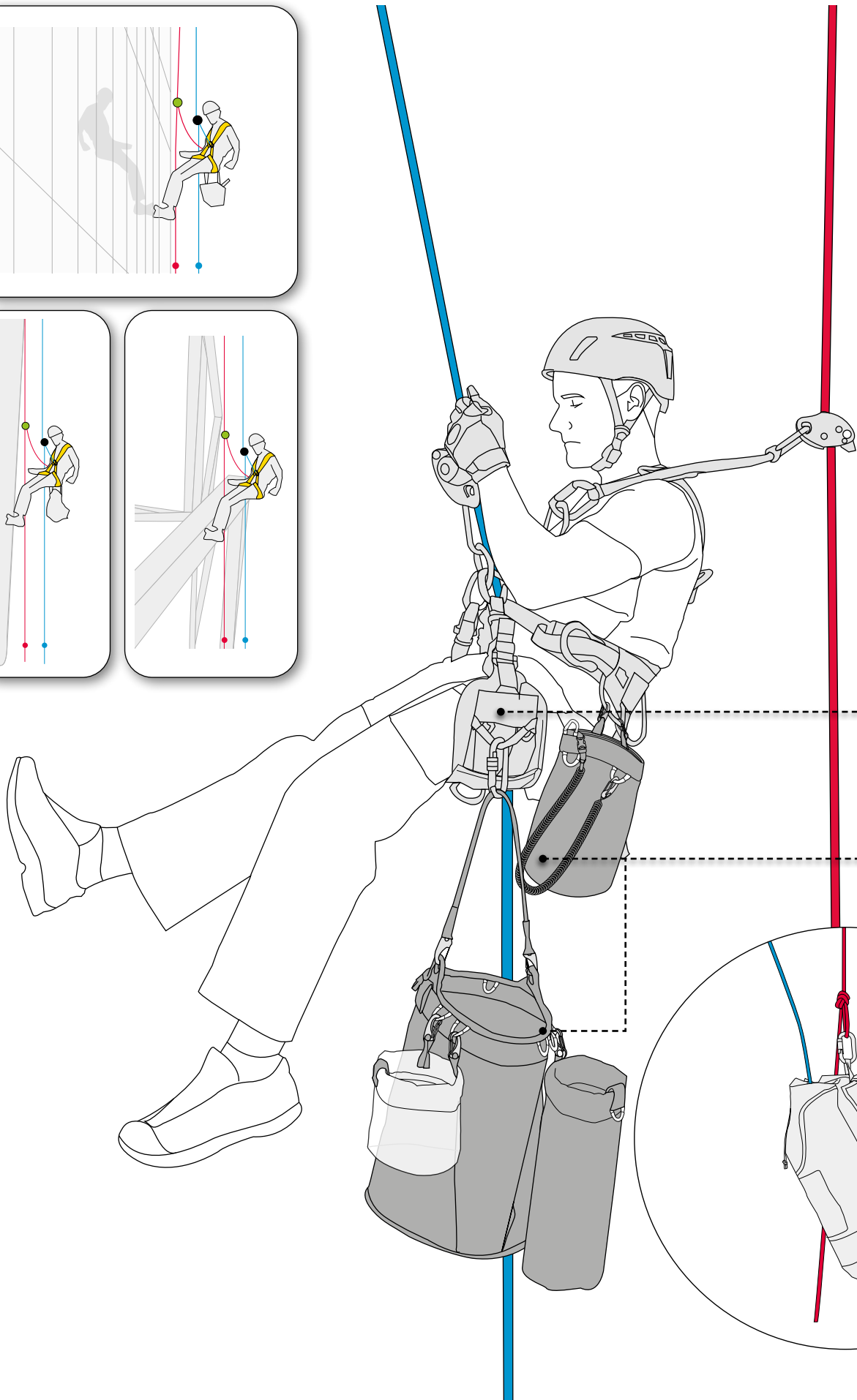
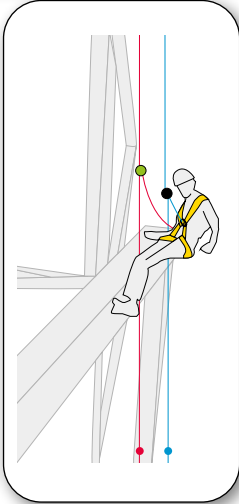
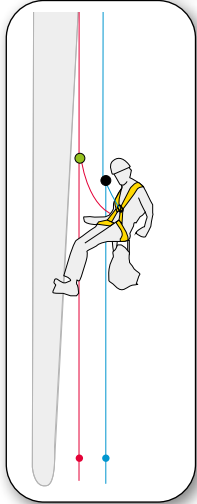
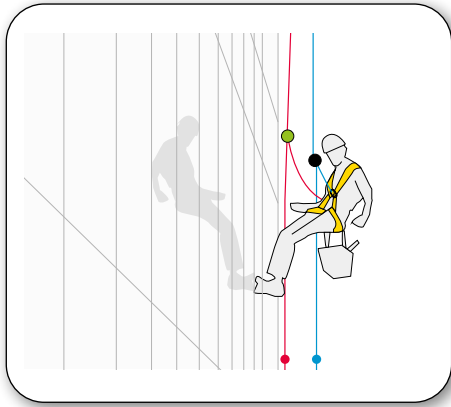

## AIR SIT p 49

Stable and comfortable suspended work seat for rope access.

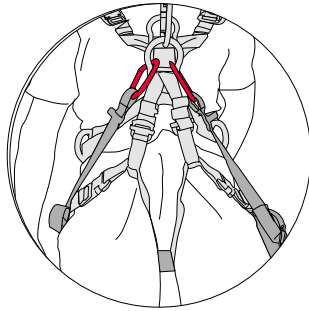

WORK SEAT ATTACHMENT

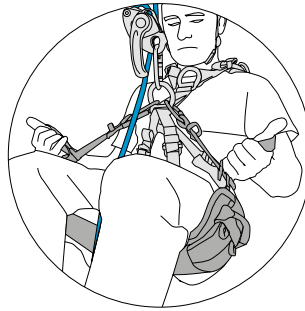

WORK SEAT ADJUSTMENT



## WORK STATION p 60-61

### TOOL BUCKET TOOL BUCKET L

Medium size tool organiser bucket.

The CLIC CLAC system can be used to quickly close the bag and prevents loss of contents during transport.



### GENIUS BUCKET

A 20 litre bucket for carrying tools as well as small screws and fittings thanks to the 3 GENIUS CLIC CLAC pockets attached to the inside. The large opening with stiffener allows easy access to its contents.



### GENIUS TOOL BUCKET

A rigid 20 litre bucket for power tools such as a hammer drill, electric screwdriver or angle grinder; constructed with a clever 'twist and fold' function to reduce size for storage. Small gear loops on the outside and inside edges of the bag can be used to attach small CLIC CLAC pockets (TOOL BUCKET, GLASS BUCKET, LONG TOOL BUCKET) to organise your work station as you wish.



Example with Tool Bucket

### GLASS BUCKET

A small transparent bucket for organising bolts, screws and other small items whilst leaving contents easily visible.

The CLIC CLAC system can be used to quickly close the bag and prevents loss of contents during transport.



## AIR LEASH

An extendable gear loop allowing tools to remain attached whilst in use.

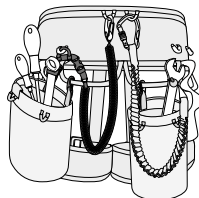

## SUPER LEASH

A webbing based extendable gear loop allowing tools to remain attached whilst in use. One end can be used to attach tools by means of a girth hitch or slipknot (it is important you select an attachment method appropriate for the specific tool). The other end is equipped with a screwgate mini-karabiner for attachment to a tool pouch or gear loop.



## ATTRAC'TOOL

A magnetic plate that allows you to temporarily attach a leash secured tool to an appropriate metal surface. The ATTRAC'TOOL can be fixed to a belt or shoulder strap of the HERO PRO harness or to the small gear loops of a harness, BUCKET or TOOL BELT.

When fitted to a harness' waist belt, a strap can be clipped around the thigh to stop the magnet from lifting up when picking up the tool. The strap can also be used to hang the ATTRAC'TOOL from a railing.

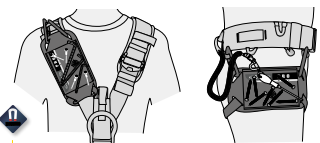
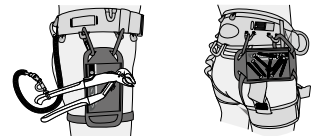

magnetic plate





## OFF SHORE WORK



p 48

**OFF SHORE**



p 36



**PRO WATER**  
11 mm

## WORK IN CHEMICAL ENVIRONMENT



p 38

**HOTLINE**  
11 mm



p 38

**RAIDER**  
11 mm



### CHEMICAL RESISTANCE OF ARAMID YARN (exposure for 100 hours)

ACIDS	Residual Tenacity in %age
Hydrochloric 20 % at 20° C	98 %
Nitric 10 % at 20° C	99 %
Sulphuric 20 % at 95° C	93 %
Sulphuric 40 % at 95° C	89 %
Acetic 40 % at 95° C	97 %
Formic 90 % at 95° C	82 %

BASES	Residual Tenacity in %age
Soda 10 % at 95° C	75 %
Wet cement at 95° C	93 %
Ammonia at 20° C	100 %

Other Chemical Products	Residual Tenacity in %age
Petrol / Gas	98 %
Benzene	98 %
Methyl Ethyl Cetone	97 %
Ethylene Glycol	94 %
Phenol	95 %
Sea water	100 %



# RESCUE

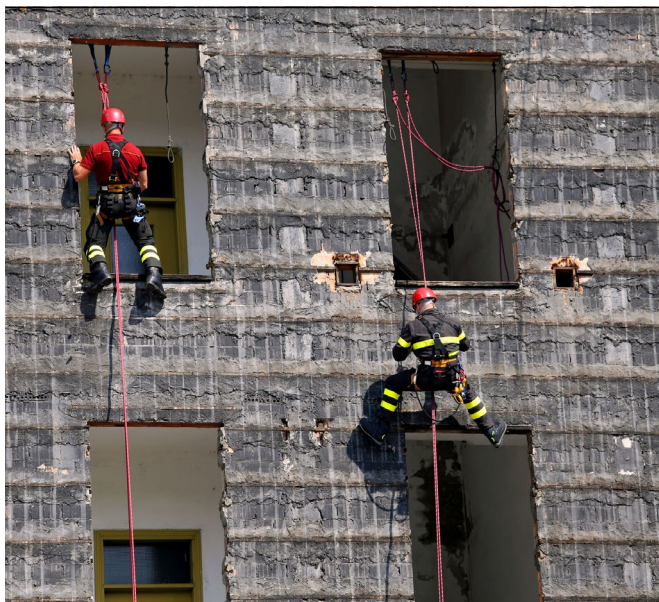

**DRAGON**



**TOP DRAGON**



**RESCUE**  
10,5 mm



**RESCUE VLS**  
11,3 mm



**RESCUE HALF INCH**  
13 mm

# WORK UNDER HIGH TEMPERATURE



**RAIDER 10,5 mm**



**RAIDER 11 mm**



**RAIDER TACTIC**  
11 mm



**HOT PROTECTOR**

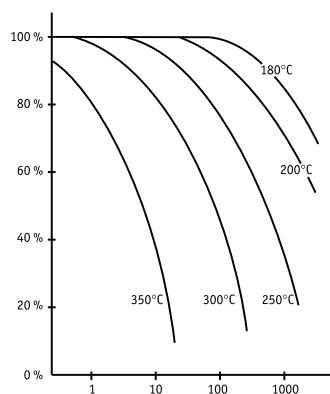

Relationship between time of exposure at high temperature and residual strength of Aramid.

## EFFECT OF HIGH TEMPERATURES ON ARAMID

The resistance of Aramid to high temperatures is best illustrated by the graph illustrating the residual strength after exposure to raised temperatures. Thus we may for

example see that after 10 hours of exposure at 200° C it retains 100 % of its strength, or that after 1 hour at 350° C it retains 90 % of its strength.

## TEST WITH BLOWTORCH

Semi-static rope holding a mass of 100 kg exposed to a temperature of 400° C (+ or- 50° C) for 15 minutes :

Results:

- Classic 11 mm rope: Break after around 40 seconds.
- RAIDER 11 mm rope: Residual strength around 1500 daN after 15 minutes.
- RAIDER TACTIC 11 mm rope: residual strength around 1000 daN after 15 minutes.

## TEST AGAINST A RED HOT BAR

The rope supports a 100 kg mass. It is held clear of a 25 mm bar heated red-hot. It is released against the bar and the time to rupture measured.

Results:

- Classic 11 mm rope: 3 seconds
- HOTLINE 11 mm: 5 seconds
- RAIDER TACTIC 11 mm: 8 seconds
- RAIDER 11 mm: 18 seconds

## ROPES















Model		Standard	Certification	Type	Breaking load	Strength with Figure-of-8 knot	Strength with sewn terminations	Number of fall factor 1	Impact force factor 0.3	Extension 50/150 kg	Sheath slippage	Weight per metre	% of the sheath	Mass of the core	Shrinkage in water	Material
<b>ROPES FOR DIFFICULT AREA ACCESS</b>																
ACCESS 10,5 mm		EN 1891	CE	A	3000 daN(kg)	1800 daN(kg)	1900 daN(kg)	12	5,3 kN	3%	0%	66g	38%	62%	2,5%	Polyamide
ACCESS 11 mm		EN 1891	CE	A	3400 daN(kg)	1950 daN(kg)	1900 daN(kg)	20	5,6 kN	2,1%	0%	74g	36%	64%	1,1%	Polyamide
INDUSTRIE 10,5 mm		EN 1891	CE	A	3000 daN(kg)	1800 daN(kg)	1900 daN(kg)	12	5,3 kN	3%	0,8%	66g	38%	62%	5%	Polyamide
INDUSTRIE 11 mm		EN 1891	CE	A	3400 daN(kg)	1950 daN(kg)	1900 daN(kg)	16	5,6 kN	2,1%	0%	74g	36%	64%	1,1%	Polyamide
INDUSTRIE 11,5 mm		EN 1891	CE	A	3500 daN(kg)	2200 daN(kg)	1900 daN(kg)	>20	5,6 kN	2,5%	0,3%	77g	38%	62%	1,5%	Polyamide
INDUSTRIE 12 mm		EN 1891	CE	A	4200 daN(kg)	2200 daN(kg)	1900 daN(kg)	>20	5,6 kN	2,5%	0,3%	94g	34%	66%	2,4%	Polyamide
CONTRACT 10,5 mm		EN 1891	CE	A	2700 daN(kg)	1600 daN(kg)	-	>5	5,5 kN	2,9%	0%	66g	39%	61%	3,3%	Polyamide
SEGMENT 11 mm		EN 1891	CE	A	3200 daN(kg)	1900 daN(kg)	1900 daN(kg)	12	5,6 kN	4,2%	0%	71g	35%	65%	4%	Polyamide
<b>FLOATING ROPE &amp; ROPE FOR DIFFICULT AREA ACCESS</b>																
PRO WATER 11 mm		EN 1891	CE	A	2500 daN(kg)	1600 daN(kg)	-	5	5,3 kN	3,6%	0%	80g	33%	67%	0%	Polyamide/ Neopren
<b>DYNAMIC ROPES</b>																
TOP GUN II 10,5 mm		EN 892	CE	Ⓢ	2100 daN(kg)	-	1700 daN(kg)	11	-	-	-	68g	40%	60%	-	
APOLLO II 11 mm		EN 892	CE	Ⓢ	2300 daN(kg)	-	-	16	-	-	-	77g	35%	65%	-	
<b>RESCUE ROPES</b>																
RESCUE 10,5 mm		EN 1891	CE	A	3000 daN(kg)	1800 daN(kg)	1900 daN(kg)	12	5,3 kN	3%	0,8%	65g	38%	62%	5%	Sheath: Polyester Core: Polyamide
RESCUE VLS 11,3 mm		NFPA	CE		3600 daN(kg)	-	-	-	-	0,8%	1,9%	94g	43%	57%		Polyester
RESCUE HALF INCH 13 mm		EN 1891	CE	A	4400 daN(kg)	2400 daN(kg)	-	20	5,4 kN	2,9%	0,2%	107g	37%	63%	0,35%	Polyamide + Melton



# ROPES

p 36-39







DATA

Model		Standard	Certification	Type	Breaking load	Strength with Figure-of-8 knot	Strength with sewn terminations	Number of fall factor 1	Impact force factor 0.3	Extension 50/150 kg	Sheath slippage	Weight per metre	% of the sheath	Mass of the core	Shrinkage in water	Material
<b>ROPES RESISTANT TO HIGH TEMPERATURES</b>																
RAIDER 10,5 mm	 	EN 1891	CE	B	2300 daN(kg)	1800 daN(kg)	1900 daN(kg)	6	4,6kN	3,2%	0%	69g	32%	68%	0,5%	Sheath: Aramid Core: Polyamide
RAIDER 11 mm	 	EN 1891	CE	B	2600 daN(kg)	1900 daN(kg)	1900 daN(kg)	8	4,7kN	3,3%	0,6%	81g	41%	59%	0,5%	
RAIDER TACTIC 11 mm	 	EN 1891	CE	A	2400 daN(kg)	1800 daN(kg)	1900 daN(kg)	6	5,9kN	3,2%	0%	75g	30%	70%	0,5%	Sheath: Aramid Core: Polyamide
<b>ROPES RESISTANT TO CHEMICAL PRODUCTS</b>																
HOTLINE 11 mm	 	EN 1891	CE	A	2500 daN(kg)	1900 daN(kg)	1900 daN(kg)	15	5,6kN	3,1%	0%	79g	42%	58%	3,3%	Sheath 1: Polyamid Sheath 2: Aramid Core: Polyamid
RAIDER 11 mm	 	EN 1891	CE	B	2600 daN(kg)	1900 daN(kg)	1900 daN(kg)	8	4,7kN	3,3%	0,6%	81g	41%	59%	0,5%	Sheath: Aramid Core: Polyamide
<b>SPECIAL ROPES</b>																
ERGO 11,5 mm		EN 1891	CE	A	3800 daN(kg)	2300 daN(kg)	1900 daN(kg)	> 20	5,6kN	2,9%	0%	101g	43%	57%	3,7%	Polyamide
<b>ROPES FOR TREE WORK</b>																
BILOBA 11,5 mm		EN 1891	CE	A	3000 daN(kg)	1800 daN(kg)	1800 daN(kg)	15	5kN	3,8%	0%	89g	44%	56%	2,8%	Sheath: Polyester Core: Polyamide
GINKGO 12 mm		EN 1891	CE	A	2700 daN(kg)	1600 daN(kg)	1900 daN(kg)	8	5,7kN	4%	0%	92g	69%	31%	2,8%	Sheath: Polyester Core: Polyamide
BONSAI 13 mm		EN 1891	CE	A	3400 daN(kg)	1800 daN(kg)	1900 daN(kg)	20	5,3kN	3,3%	0%	101g	61%	39%	3,7%	Polyamide
<b>ROPES FOR PRUSIKS</b>																
VOLCANO 8 mm		EN 564	CE	-	1600 daN(kg)	-	-	-	-	-	-	48 g	-	-	-	Polyamide/Aramid









## ACCESSORY CORDS

p 42

	WEIGHT PER METER	BREAKING LOAD		MATERIAL	CERTIFICATION	STANDARD
4 mm 	11 g	400 daN (kg)	530 daN (kg)	Polyamide	CE/UIAA	EN564
5 mm 	19,5 g	650 daN (kg)	930 daN (kg)	Polyamide	CE/UIAA	EN564
5.5 mm Dyneema 	20 g	1800 daN (kg)	2000 daN (kg)	Sheath: Polyamide Core : Dyneema	CE/UIAA	-
6 mm 	23 g	810 daN (kg)	1200 daN (kg)	Polyamide	CE/UIAA	EN564
7 mm 	31 g	1170 daN (kg)	1680 daN (kg)	Polyamide	CE/UIAA	EN564
8 mm 	40 g	1530 daN (kg)	2200 daN (kg)	Polyamide	CE/UIAA	EN564

## WEBBING

p 42

	WEIGHT PER METER	BREAKING LOAD		MATERIAL	CERTIFICATION	STANDARD	CONDITIONING
Tubular 16 mm 	31 g	1350 daN (kg)	1800 daN (kg)	Polyamide	CE/UIAA	EN 565	100 m
Tubular 26 mm 	38 g	1500 daN (kg)	2000 daN (kg)	Polyamide	CE/UIAA	EN 565	100 m
Tape 18 mm 	39 g	1600 daN (kg)	1800 daN (kg)	Polyamide	CE/UIAA	EN 565	100 m
Tape 26 mm 	35 g	1500 daN (kg)	1900 daN (kg)	Polyamide	CE/UIAA	EN 565	100 m
Tape 45 mm 	55 g	2200 daN (kg)	2600 daN (kg)	Polyamide	CE/UIAA	EN 565	80 m

## FLAT SLINGS

p 42

	WEIGHT	BREAKING LOAD	LENGTH	MATERIAL	CERTIFICATION	STANDARD	CONDITIONING
18 mm 	60 cm = 48 g	2200 daN (kg)	30 / 40 / 50 / 60 / 80 / 100 / 120 / 150 / 175 cm	Polyamide	CE/UIAA	EN 566 EN 795B EN 354	5
10 mm 	60 cm = 19,8 g	2200 daN (kg)	60 / 120 / 180 cm	Dyneema	CE/UIAA	EN 566 EN 795B EN 354	4
10 mm 	240 cm = 79 g	2200 daN (kg)	240 cm	Dyneema	CE/UIAA	EN 566 EN 795B	4

## DYNALOOP / EYE LOOP

p 43

	LENGTH	WEIGHT	BREAKING LOAD	MATERIAL	STANDARD
DYNALOOP 	60 cm	55 g	2200 daN (kg)	Polyamide	CE EN 566 / CE EN 354
DYNALOOP 	120 cm	105 g	2200 daN (kg)	Polyamide	CE EN 566 / CE EN 354
DYNALOOP 	150 cm	135 g	2200 daN (kg)	Polyamide	CE EN 566 / CE EN 354
EYE LOOP 	60 cm	100 g	3000 daN (kg) 2200 daN (kg) girth hitch	Polyamide	CE EN 566 / CE EN 354
EYE LOOP 	80 cm	125 g	3000 daN (kg) 2200 daN (kg) girth hitch	Polyamide	CE EN 566 / CE EN 354
EYE LOOP 	120 cm	170 g	3000 daN (kg) 2200 daN (kg) girth hitch	Polyamide	CE EN 566 / CE EN 354
EYE LOOP 	150 cm	200 g	3000 daN (kg) 2200 daN (kg) girth hitch	Polyamide	CE EN 566 / CE EN 354

## ESCAPER

p 43

	WEIGHT	STRENGTH	STANDARD
ESCAPER 	100 g	18 kN	CE EN 795B

## NOT ADJUSTABLE DYNAMIC LANYARDS

p 45

		LENGTH	WEIGHT	STANDARD
Dynapro		0,60 m	140 g	CE EN 354 / EN 795B
		1,00 m	170 g	CE EN 354 / EN 795B
		1,50 m	200 g	CE EN 354 / EN 795B
Dynapro 8		1,60 m	250 g	CE EN 354
Dynapro V		0,30 m / 0,60 m 1,00 m 1,50 m		CE EN 354 / EN 795B CE EN 354 / EN 795B CE EN 354 / EN 795B

## NOT ADJUSTABLE STATIC LANYARDS

p 45

		LENGTH	WEIGHT	STANDARD
Nexus I		0,60 m	50 g	CE EN 354 / EN 795B
		0,80 m	65 g	CE EN 354 / EN 795B
Nexus V		0,80 m	100 g	CE EN 354 / EN 795B

## FALL ARREST LANYARDS

p 46











		CONNECTORS	LENGTH	WEIGHT	STANDARD
Dynapro-Air Hook		1x O'light 3-matic + 2x Air Hook L	1,00 m	880 g	CE EN 355 / EN 362
		1x O'light 3-matic + 2x Air Hook L	1,50 m	920 g	CE EN 355 / EN 362
		1x O'light 3-matic + 2x Air Hook L	2,00 m	970 g	CE EN 355 / EN 362
Dynapro-Air V Hook		1x O'light 3-matic + 2x Air Hook L	1,00 m	1450 g	CE EN 355 / EN 362
		1x O'light 3-matic + 2x Air Hook L	1,50 m	1530 g	CE EN 355 / EN 362
Dynapro-Air V Hook XL		1x O'light 3-matic + 2x Air Hook XL	2,00 m	2530 g	CE EN 355 / EN 362 CE EN 355 / EN 362



DATA









## HARNESSES

Model	Size	Waist	Leg loop	Chest loop	Height	Chest height	Certification	Weight	Sternal attachment points	Dorsal attachment points	Ventral attachment points	Lateral attachment points
<b>FALL ARREST HARNESS</b>												
STYX RESCUE 	Universel	40-80 cm	55-80 cm	80-140 cm	160-195 cm	-	CE EN 361	1062 g	✓	✓	-	-
STYX RESCUE JACKET 	Universel	40-80 cm	55-80 cm	80-140 cm	160-195 cm	-	CE EN 361	1062 g	✓	✓	-	-
STYX FAST 	1 (S-M-L)	65-105 cm	45-65 cm	80-120 cm	160-180 cm	55-75 cm	CE EN 361	1700 g	✓	✓	-	-
	2 (L-XL)	100-130 cm	60-75 cm	90-140 cm	175-210 cm	65-85 cm		1750 g	✓	✓	-	-
<b>WORKSTATION BELT</b>												
STYX BELT 	Universel	70-140 cm	-	-	-	-	CE EN 358	780 g	+	+	+	✓
<b>FALL ARREST, ROPE ACCESS AND WORK POSITIONING HARNESS</b>												
SOLACE 	S	65-85 cm	40-60 cm	-	155-175 cm	-	CE EN 361 (140 kg) CE EN 358 (140 kg) CE EN 813 (140 kg)	2180 g	✓	✓	✓	✓
	M-L	78-100 cm	50-65 cm	-	165-185 cm	-		2270 g	✓	✓	✓	✓
	XL	85-100 cm	55-70 cm	-	175-210 cm	-		2350 g	✓	✓	✓	✓
SOLACE HOLD UP 	S	65-85 cm	40-60 cm	-	155-175 cm	-	CE EN 361 (140 kg) EN 358 (140 kg) EN 813 (140 kg) CE EN 567 : Ø 8-13 mm CE EN 12841 : 2006-B : Ø 10-13 mm 100 kg	2340 g	✓	✓	✓	✓
	M-L	78-100 cm	50-65 cm	-	165-185 cm	-		2430 g	✓	✓	✓	✓
	XL	85-100 cm	55-70 cm	-	175-210 cm	-		2510 g	✓	✓	✓	✓
OFF SHORE 	1 (S-M-L)	70-105 cm	50-65 cm	-	160-180 cm	-	CE EN 361 CE EN 358 CE EN 813	1920 g	✓	-	✓	✓
	2 (L-XL)	85-130 cm	60-75 cm	-	175-210 cm	-		2080 g	✓	-	✓	✓
HERO PRO 	S	70-90 cm	50-65 cm	70-100 cm	155-175 cm	55-70 cm	CE EN 361 CE EN 358 CE EN 813	2065 kg	✓	✓	✓	✓
	M-L	80-105 cm	55-65 cm	80-120 cm	170-185 cm	65-80 cm		2125 kg	✓	✓	✓	✓
	XL	90-130 cm	60-70 cm	100-140 cm	180-210 cm	75-85 cm		2230 kg	✓	✓	✓	✓
HERO PRO HOLD UP 	S	70-90 cm	50-65 cm	70-100 cm	155-175 cm	55-70 cm	CE EN 361 EN 358 EN 813 CE EN 567 : Ø 8-13 mm CE EN 12841 : 2006-B : Ø 10-13 mm 100 kg	2065 kg	✓	✓	✓	✓
	M-L	80-105 cm	55-65 cm	80-120 cm	170-185 cm	65-80 cm		2125 kg	✓	✓	✓	✓
	XL	90-130 cm	60-70 cm	100-140 cm	180-210 cm	75-85 cm		2230 kg	✓	✓	✓	✓
<b>ROPE ACCESS AND WORK POSITIONING HARNESS</b>												
HERO SIT 	S	70-90 cm	50-65 cm	-	-	-	CE EN 358 CE EN 813	1437 g	-	-	✓	✓
	M-L	80-105 cm	55-65 cm	-	-	-		1478 g	-	-	✓	✓
	XL	90-130 cm	60-70 cm	-	-	-		1568 g	-	-	✓	✓
SHAOLIN 	S	60-100 cm	42-60 cm	-	-	-	CE EN 358 CE EN 813	700 g	-	-	✓	✓
	M-L	72-120 cm	52-70 cm	-	-	-		760 g	-	-	✓	✓
	XL	85-140 cm	57-75 cm	-	-	-		810 g	-	-	✓	✓











# HARNESSES

p 51

Model	Size	Waist	Leg loop	Chest loop	Height	Chest height	Certification	Weight	Sternal attachment points	Dorsal attachment points	Ventral attachment points	Hip attachment points
<b>RESCUE HARNESSES</b>												
DRAGON 	1 (S-M-L)	68-100 cm	42-62 cm	-	-	-	CE EN 358 CE EN 813	900 g	✓ with chest TOP DRAGON	✓	✓	✓
	2 (L-XL)	72-125 cm	50-70 cm	-	-	-		960 g	✓ with chest TOP DRAGON	✓	✓	✓
TRI-ANGEL 	Universel	60-100 cm	42-60 cm	-	-	-	CE EN 1497 : 2007 CE EN 1498 : 2006	747 g	-	-	-	-
		72-120 cm	52-70 cm	-	-	-			-	-	-	-
		85-140 cm	57-75 cm	-	-	-			-	-	-	-
<b>HARNESSES ACCESSORIES</b>												
DRAGON TOP 	Universel	-	-	-	60-140 cm	-	CE EN 361	470 g	✓	✓	✓	-
AIR TOP 	Universel	-	-	-	60-140 cm	-	CE EN 361 CE EN 12277 type D	345 g	✓	-	✓	-
YPSILON 	Universel	-	-	-	60-140 cm	-	CE EN 361	370 g	✓	-	✓	-
AIR SIT 	Universel 50x28x12 cm	-	-	-	-	-	CE EN 361	-	-	-	-	-

# HELMETS



p 52-53

	SIZE	CIRCOMFERENCE	CHINSTRAP	ADJUSTMENT	COLORS	WEIGHT	STANDARD
QUANTUM 	Universel	53 < 63 cm	15-25 daN			400 g	CE EN 397
QUANTUM ELEC 	Universel	53 < 63 cm	15-25 daN			400 g	CE EN 397 / EN 50365
QUANTUM VISOR 	230x110x100 mm	-	-	-	-	50 g	CE EN 166
QUANTUM V PROTECT 	230x110x100 mm	-	-	-	-	63 g	-

DATA





## CONNECTOR

		DIMENSIONS	OPENING				WEIGHT	STANDARD
O'Light		111 x 61 cm	17 mm	22 kN	8 kN	6 kN	74 g	CE EN 362:2004/B CE EN 12275:2013⊗
O'Light 3-matic		111 x 61 cm	17 mm	22 kN	8 kN	6 kN	82 g	CE EN 362:2004/B CE EN 12275:2013⊗
Be Quick		105 x 60 mm	19 mm	23 kN	9 kN	8 kN	44 g	CE EN 362:2004/B CE EN 12275:2013⊕
Be Link		108 x 66 cm	20 mm	26 kN	8 kN	7 kN	65 g	CE EN 362:2004/B CE EN 12275:2013⊕
Be Link Bi-matic		108 x 66 cm	20 mm	26 kN	8 kN	7 kN	65 g	CE EN 362:2004/B CE EN 12275:2013⊕
Be Link 3-matic		108 x 66 cm	20 mm	26 kN	8 kN	7 kN	65 g	CE EN 362:2004/B CE EN 12275:2013⊕
Be Lock		121 x 76 cm	22 mm	26 kN	8 kN	8 kN	86 g	CE EN 362:2004/B CE EN 12275:2013⊕
Be Lock 3-matic		121 x 76 cm	22 mm	26 kN	8 kN	8 kN	100 g	CE EN 362:2004/B CE EN 12275:2013⊕
Flat link Bi-matic		85 x 71 cm	16 mm	20 kN	10 kN	5 kN	81 g	CE EN 362:2004/B
O'Smith		109 x 56 cm	17 mm	30 kN	16 kN	8 kN	179 g	CE EN 362:2004/B,A,T CE EN 12275:2013⊕
O'Smith 3-matic		109 x 56 cm	17 mm	30 kN	16 kN	8 kN	198 g	CE EN 362:2004/B,A,T CE EN 12275:2013⊕
Air-Smith		114 x 73 cm	25 mm	52 kN	16 kN	18 kN	251 g	CE EN 362:2004/B,A,T CE EN 12275:2013⊕
Air-Smith 3-matic		114 x 73 cm	25 mm	52 kN	16 kN	18 kN	251 g	CE EN 362:2004/B,A,T CE EN 12275:2013⊕
Air-Hook Large		240 x 120 cm	60 mm	22 kN	-	-	475 g	CE EN 362:2004/A
Air -Hook XL		360 x 165 cm	110 mm	25 kN	-	-	920 g	CE EN 362:2004/A-T



## QUICK LINKS

p 55

		WORKING LOAD LIMIT	BREAKING LOAD (KG)	WEIGHT	LENGHT	WIDTH	OPENING
STANDARD GALVA 8 mm		700	3500	77 g	73 mm	34 mm	11.4 mm
STANDARD GALVA 10 mm		1100	5500	137 g	88 mm	41.5 mm	12 mm
LONG OPENING GALVA 7 mm		500	2500	60 g	78.5 mm	31 mm	16 mm
PEAR GALVA 10 mm		720	3600	185 g	118 mm	65 mm	20 mm
DELTA GALVA 8 mm		550	2750	88 g	73 mm	56 mm	11 mm
DELTA GALVA 10 mm		990	4500	153 g	87 mm	66 mm	12 mm
SEMI CIRCULAR 10 mm		990	4500	153 g	86 mm	65 mm	10 mm
DELTA TWIST		600	3000	135 g	93 mm	62 mm	12 mm

## RIGGING PLATES AND SWIVEL

p 55

		DIMENSIONS	COMPATIBLE DIAMETER	MAXIMUM LOAD	WEIGHT	STANDARD
AIR-PORT 4		85,4 x 82,5 mm	MBS 45 kN WLL 9 kN	23,5 mm	92 g	CE
AIR-PORT 6		84,5 x 173,6 cm	MBS 45 kN WLL 9 kN	20 mm	188 g	CE
TWIST'AIR B		150 x 83 cm	MBS 22 kN WLL 4 kN	23,5 mm	88 g	CE EN 354

## PULLEYS

p 55



		DIMENSIONS	SHEAVE DIAMETER	ROPE DIAMETER COMPATIBILITY	MAXIMUM LOAD	BALL BEARINGS	WEIGHT	STANDARD
Transf'Air 1		118 x 83 cm	Ø 48,7 mm	16 mm	MBS 30 kN	-	270 g	CE EN 12278 : 2007
Transf'Air 1 B		118 x 83 cm	Ø 48,7 mm	16 mm	MBS 30 kN	✓	280 g	CE EN 12278 : 2007
Transf'Air 2		150 x 83 cm	Ø 48,7 mm	16 mm	MBS 30 kN	-	476 g	CE EN 12278 : 2007
Transf'Air 2 B		150 x 83 cm	Ø 48,7 mm	16 mm	MBS 30 kN	✓	500 g	CE EN 12278 : 2007
Transf'Air Fixe		82 x 45 cm	Ø 22,4 mm	12 mm	MBS 20 kN	-	90 g	CE EN 12278 : 2007
Transf'Air Fixe B		82 x 45 cm	Ø 26,2 mm	13 mm	MBS 22 kN	✓	120 g	CE EN 12278 : 2007
Transf'Air Twin B		76 x 108 cm	Ø 26,2 mm	13 mm cable or rope	MBS 30 kN	✓	282 g	CE EN 12278 : 2007
Transf'Air Mini		80 x 68 cm	Ø 27 mm	11 mm	MBS 20 kN	-	120 g	CE EN 12278 : 2007

DATA







## DESCENDERS

p 56

		COMPATIBLE DIAMETER	WEIGHT	STANDARD
Air Stop 		Ø 9 < 12 mm	429 g	CE EN 341 / EN 12841
Air Force 8 		-	120 g	-

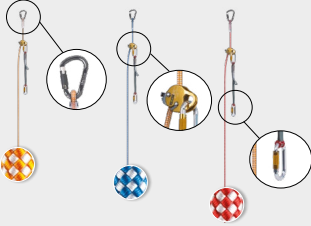

## FALL ARREST

p 57

		COMPATIBLE DIAMETER	WEIGHT	STANDARD
MONITOR 		Ø 11 < 13 mm	170 g	CE EN 353-2 / EN 12841-A 100 kg
SOFT AIR KIT 		10 m	1210 g	CE EN 353-2 (140 kg)
AIR KIT 11 MM 		10 m & 30 m : Orange 15 m & 50 m : Blue 20 m & 60 m : Red	1430 g & 2600 g 1800 g & 4430 g 2080 g & 5200 g	CE EN 353-2 / EN 12841-A 100 kg CE EN 353-2 / EN 12841-A 100 kg CE EN 353-2 / EN 12841-A 100 kg
MOBILE LANYARD 		20 cm / 40 cm	64 g	CE EN 354

## ROPE CLAMPS

p 58

		COMPATIBLE DIAMETER	WEIGHT	STANDARD
Hands up 		8 < 13 mm	265 g	CE EN 567 : 2013 Ø8-13 mm CE EN 12841 : 2006-B Ø10-13 mm 100 kg
Hold up 		8 < 13 mm	90 g	CE EN 567 : 2013 Ø8-13 mm CE EN 12841 : 2006-B Ø10-13 mm 100 kg
Tract up 		Ø 8 < 11 mm	80 g	CE EN 567 : 2013 Ø8-13 mm



# ROPES FOR DIFFICULT AREA ACCESS

## ACCESS 10,5 mm

Thanks to the UNICORE Process, Access ropes reach a new level in security. In effect, the UNICORE Process integral to this 10,5 mm rope will secure most delicate operations, whilst retaining lightness and flexibility.

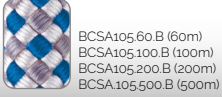

BCSA105.60.B (60m)  
BCSA105.100.B (100m)  
BCSA105.200.B (200m)  
BCSA.105.500.B (500m)



BCSA105.60.O (60m)  
BCSA105.100.O (100m)  
BCSA105.200.O (200m)  
BCSA.105.500.O (500m)

## ACCESS 11 mm

With UNICORE as standard, bonding core and sheath for maximum security in all situations.

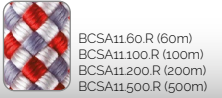

BCSA11.60.R (60m)  
BCSA11.100.R (100m)  
BCSA11.200.R (200m)  
BCSA11.500.R (500m)



BCSA11.60.Y (60m)  
BCSA11.100.Y (100m)  
BCSA11.200.Y (200m)  
BCSA11.500.Y (500m)

## INDUSTRIE 10,5 mm

This rope is specially adapted to the requirements of work at height companies.



BCSI105.50 (50m)  
BCSI105.60 (60m)  
BCSI105.100 (100m)  
BCSI105.200 (200m)  
BCSI105.500 (500m)



BCSI105.60.B (60m)  
BCSI105.100.B (100m)  
BCSI105.200.B (200m)



BCSI105.50.R (50m)  
BCSI105.60.R (60m)  
BCSI105.100.R (100m)  
BCSI105.200.R (200m)  
BCSI105.500.R (500m)



BCSI105.50TERM2 (50 m)

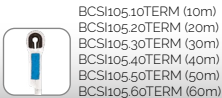

BCSI105.10TERM (10m)  
BCSI105.20TERM (20m)  
BCSI105.30TERM (30m)  
BCSI105.40TERM (40m)  
BCSI105.50TERM (50m)  
BCSI105.60TERM (60m)



BCSI105.50TERM.B (50m)



BCSI105.30TERMR (30m)  
BCSI105.40TERMR (40m)



BCSI105.50TERM2.R (50 m)

## INDUSTRIE 11 mm

An ideal rope with no diameter restrictions for security in work at height.



BCSI11.50.B (50m)  
BCSI11.100.B (100m)  
BCSI11.200.B (200m)  
BCSI11.500.B (500m)



BCSI11.100.O (100m)  
BCSI11.200.O (200m)  
BCSI11.500.O (500m)

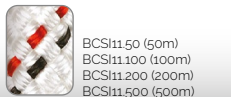

BCSI11.50 (50m)  
BCSI11.100 (100m)  
BCSI11.200 (200m)  
BCSI11.500 (500m)



BCSI11.50.R (50m)  
BCSI11.100.R (100m)  
BCSI11.200.R (200m)  
BCSI11.500.R (500m)



BCSI11.10TERM (10m)  
BBCI11.20TERM (20m)  
BCSI11.30TERM (30m)  
BCSI11.40TERM (40m)  
BCSI11.50TERM (50m)  
BCSI11.60TERM (60m)



BCSI11.10TERMR (10m)  
BCSI11.20TERMR (20m)  
BCSI11.30TERMR (30m)  
BCSI11.40TERMR (40m)  
BCSI11.50TERMR (50m)

## INDUSTRIE 11,5 mm

Great abrasion resistance for the most demanding applications.



BCSI115.50 (50m)  
BCSI115.200 (200m)



BCSI115.50.R (50m)  
BCSI115.200.R (200m)



DATA

## INDUSTRIE 12 mm

An ideal work at height rope when a large rope diameter is required for greater security.



BCSI12.50 (50m)  
BCSI12.200 (200m)



BCSI11.50 R (50m)  
BCSI12.200 R (200m)

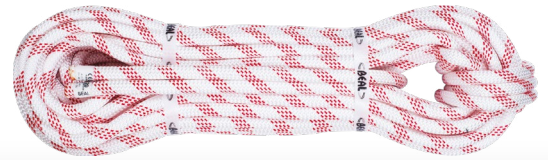

## CONTRACT 10,5 mm

Type A rope with the optimum balance quality/price.



BCS105C.20 (20m)  
BCS105C.30 (30m)  
BCS105C.40 (40m)  
BCS105C.50 (50m)  
BCS105C.60 (60m)

BCS105C.80 (80m)  
BCS105C.100 (100m)  
BCS105C.200 (200m)  
BCS105C.500 (500m)



## SEGMENT 11 mm

Rope for work at height with the optimum quality price ratio.



BCS11S.50 (50m)  
BCS11S.100 (100m)  
BCS11S.200 (200m)  
BCS11S.500 (500m)



## FLOATING ROPE & ROPE FOR DIFFICULT AREA ACCESS

### PRO WATER 11 mm



Floating type A semi-static rope for work at height above water (off-shore wind farms, oil rigs).



BCSW11.60 (60m)  
BCSW11.100 (100m)  
BCSW11.200 (200m)



## DYNAMIC ROPES

### TOP GUN II 10,5 mm



Dynamic ropes cushion impacts and must be used during certain procedures to absorb the energy of possible falls.



BC105T.50.G (50m)  
BC105T.60.G (60m)  
BC105T.70.G (70m)  
BC105T.200.G (200m)



BC105T.50.B (50m)  
BC105T.60.B (60m)  
BC105T.70.B (70m)  
BC105T.200.B (200m)



### APOLLO II 11 mm

Dynamic ropes cushion impacts and must be used during certain procedures to absorb the energy of possible falls.



BC11A.50.R (50m)  
BC11A.60.R (60m)  
BC11A.200.R (200m)



BC11A.50.A (50m)  
BC11A.60.A (60m)  
BC11A.200.A (200m)



## RESCUE ROPES

### RESCUE 10,5 mm

Semi-static type A rope with a polyester sheath. Its fluorescent orange colour make it particularly suited for use in rescues.



BCSR105.50 (50m)  
BCSR105.100 (100m)  
BCSR105.200 (200m)



### RESCUE VLS 11,3 mm

The Rescue VLS is a very low stretch rope designed for technical rope rescue. VLS for Very Low Stretch. Elongation 50-150kg : 0,8%



BCSR113.200.Y (200m)



BCSR113.200.BK (200m)



### RESCUE HALF INCH 13 mm

Rope for rescue teams using American methods.



BCSR13.300 (300m)



## ROPES RESISTANT TO HIGH TEMPERATURES

### RAIDER 10,5 mm



Semi-static Type B rope with an Aramid sheath capable of withstanding a long period close to a major source of heat.



BCSK105R.50 (50m)  
BCSK105R.200 (200m)



Sheath Aramid Core



### RAIDER 11 mm



Semi-static Type B rope with an Aramid sheath capable of withstanding a long period close to a major source of heat.



BCSK11R.50 (50m)  
BCSK11R.70 (70m)  
BCSK11R.200 (200m)



Sheath Aramid Core



### RAIDER TACTIC 11 mm



The thickness of the sheath of RAIDER TACTIC has been reduced and the quantity of the core increased Sheath Aramid Core to allow it to be certified as a Type A rope.



BCSK11RT.50 (50m)  
BCSK11RT.200 (200m)



Sheath Aramid Core



DATA





## ROPES RESISTANT TO CHEMICAL PRODUCTS



### HOTLINE 11 mm



Semi-static rope with an interior sheath in Aramid, covered by a classic sheath. HOTLINE rope allows access in the presence of certain dangerous chemicals.



BCSK11200 (200m)  
BCSK1150 (50m)



Sheath Aramid Core

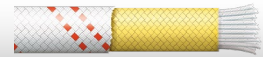

### RAIDER 11 mm



Semi-static Type B rope with an Aramid sheath capable of withstanding a long period close to a major source of heat.



BCSK11R.50 (50m)  
BCSK11R.70 (70m)  
BCSK11R.200 (200m)



Sheath Aramid Core



## SPECIAL ROPES

### ERGO 12,5 mm

Designed to meet the needs of firefighters in their different tasks, conforming to civil security code NIT no. 129-83-92 and to the Standard EN 1891.



BCS125.200 (200m)



BCS125.30TERM2 (30m)  
BCS125.60TERM2 (60m)





## ROPES FOR TREE WORK

### BILOBA 11,5 mm

A lightweight arborist rope specially designed for use with mechanical Prusiks. Its double braided construction makes the rope particularly supple. Fluorescent colours ensure the rope is highly visible. Materials: polyester sheath, polyamide core



BCSE115.200 (200m)



BCSE115.60TERM (60m)

### GINKGO 12 mm

Made along the same lines as the BAOBAB, its thinner diameter makes a lighter rope, more supple and easier to handle than BAOBAB. It benefits from a new, glueless procedure for bonding the sheath onto the core, preventing all slippage, but still allowing splices to be made.



BCSE12.200 (200m)



BCSE12.20TERM (20m)  
BCSE12.30TERM (30m)  
BCSE12.40TERM (40m)  
BCSE12.50TERM (50m)  
BCSE12.60TERM (60m)



BCSE12.3TERM2 (3m)  
BCSE12.4TERM2 (4m)  
BCSE12.5TERM2 (5m)

BCSE12.20TERM2 (20m)  
BCSE12.30TERM2 (30m)  
BCSE12.35TERM2 (35m)

BCSE12.40TERM2 (40m)  
BCSE12.50TERM2 (50m)  
BCSE12.60TERM2 (60m)

### BONSAI 13 mm

This multi-use rope, with an excellent handling/solidity balance, allows you to undertake all types of tree work in full security.



BCSE13.200 (200m)



BCSE13.30TERM (30m)  
BCSE13.40TERM (40m)



BCSE13.30TERM2 (30m)  
BCSE13.40TERM2 (40m)

## ROPES FOR PRUSIKS

### PRUSIKS VOLCANO 8 / 10 / 12 mm

Short lengths of rope with sewn terminations for constructing self-locking (prusik) loops. These ropes have a 50 % aramid construction intermixed with polyester filaments. Prusiks made from classic ropes have a very short life, because they glaze in use due to the effect of friction. The presence of 50 % of highly thermally resistant aramid fibres in VOLCANO protect it against melting and thus greatly increases its lifetime. Available in 10 and 12 mm, and 70 and 90 cm lengths, to suit different types of knots.

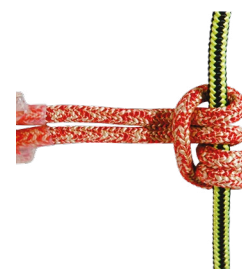
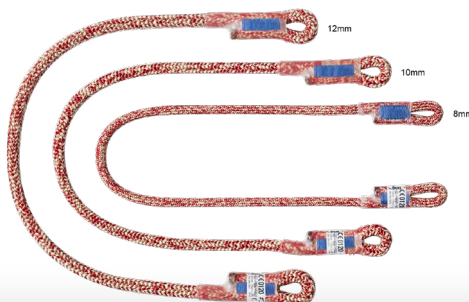

8 mm : BV08.70 (70cm) / BV08.90 (90cm)  
10 mm : BV10.70 (70cm) / BV10.90 (90cm)  
12 mm : BV12.70 (70cm) / BV12.90 (90cm)

### VOLCANO 8 mm



BCSVo8

DATA



DATA

## ACCESSORY CORDS

Multi-use: BEAL accessory cords from 4 to 8 mm in diameter conform to the requirements of the UIAA and European Standards.

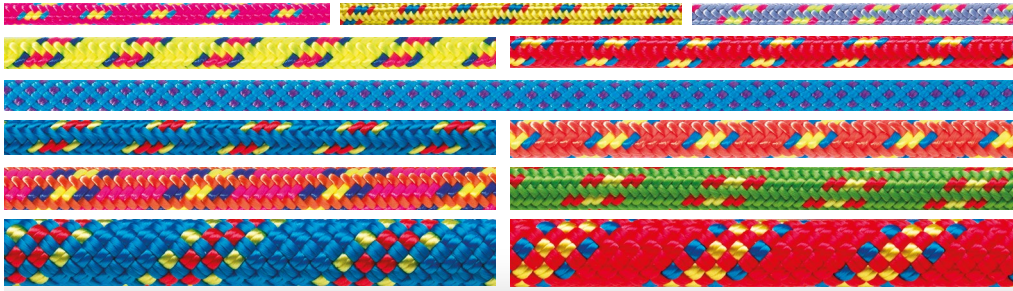

- 4 mm : BC04.120.Y/GY/V
- 5 mm : BC05.120.Y/R
- Dyneema 5,5 mm : BC055DYN.50
- 6 mm : BC06.120.O/B
- 7 mm : BC07.120.O
- 8 mm : BC08.200.R/B

## WEBBING

Tubular for their flexibility or flat for their durability, webbings are specifically used in belay slings. Cut webbing must always be tied with a tape knot.

### TUBULAR - 16 mm



BST16.G

### FLAT SUPER - 18 mm



BSP18.B

### FLAT - 26 mm



BSP26UNI.BK

### TUBULAR - 26 mm



BST26.B



BSP18.GY



BSP26UNI.F



BST26.R

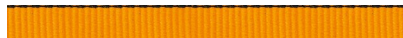

BSP18.O

### FLAT - 45 mm



BSP45



BSP18.R



BSP26UNI.G

## POLYAMIDE FLAT SLINGS 18 mm



50 cm  
100 cm

30 cm  
80 cm  
175 cm

60 cm  
150 cm

30 cm 100 cm  
40 cm 120 cm  
50 cm 150 cm  
60 cm 175 cm  
80 cm

40 cm  
120 cm

40 cm Orange/Black: BSA40.5  
60 cm Red/Black: BSA60.5  
80 cm Blue/Black: BSA80.5

100 cm Grey/Black: BSA100.5  
120 cm Orange/Black: BSA120.5  
150 cm Red/Black: BSA150.5

## DYNEEMA FLAT SLINGS 10 mm



60 cm

BSAD10.60.5

120 cm

BSAD10.120.5

180 cm

BSAD10.180.5

240 cm

BSAD10.240.5

## DYNALOOP

A dynamic rope sling for work restraint. The dynamic characteristics of this sling are far superior to those of a traditional static lanyard or webbing sling.

### Strengths :

- ▶ Perfectly adapted for work positioning at height.
- ▶ The use of a dynamic rope can improve the level of safety.
- ▶ Sewn termination protected by a heat shrink cover.
- ▶ Breaking load 2200 daN
- ▶ Marked with a unique serial number



## EYE LOOP

A heavy duty tubular webbing sling with connecting buckle and wear indicator.

### Strengths :

- ▶ Strength 30kN
- ▶ Strength 22kN when used in a girth hitch configuration
- ▶ Double thickness webbing with a red webbing liner. The liner acts as a wear indicator: the product should be retired when the red webbing becomes visible.
- ▶ Strength of the red webbing 22kN
- ▶ Width 19mm
- ▶ Material: Polyamide
- ▶ Available in 4 lengths: 60 cm yellow / 80 cm green / 120 cm red / 150 cm black

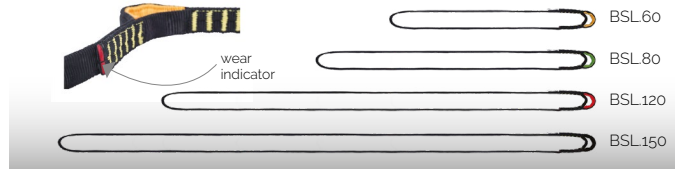

## ESCAPER

Detachable anchor system. The ESCAPER allows you to use a single length of rope and to rappel it from remove locations. It can be used with all rope diameters, the limits being imposed by the braking device that is used with the rope. It works with rope lengths up to 80m. The length can be limited by the friction of the rope.

To retrieve the ESCAPER, pull then / release the rope. It takes an average of 8 consecutive pull/release motions to detach and retrieve the ESCAPER.

### Points forts :

- ▶ Extremely safe, it only requires a tension of 10 kg to avoid the locking system from sliding.
- ▶ A total loosening of the tension on the rope generates a sliding of a few centimeters.
- ▶ A sliding of at least 50 cm is necessary to detach the system.
- ▶ Very light: made of rope, webbing and bungee band (100 % textile).

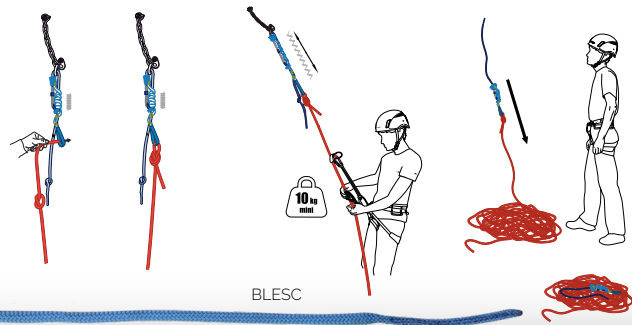

Resistance : 1800 daN (kg)

## ADJUSTABLE LANYARDS

### ADJUST'AIR

Adjustable (EN358) work positioning lanyard in 12,5mm semi-static rope.

### Strengths :

- ▶ Ergonomic, captive rope clamp.
- ▶ Available in 3 lengths: 2 m / 3 m / 5 m.
- ▶ Sewn termination with reinforced eye to protect the rope.
- ▶ Removable cover allows the inspection of termination stitches.
- ▶ Tubular protection webbing for the rope.
- ▶ Marked with a unique serial number and labelled to accommodate personal markings.



2 m: BLSAA.200  
3 m: BLSAA.300  
5 m: BLSAA.500

## PINCH

System for securing the karabiner at the end of a rope or tape lanyard. Made out of particularly strong material, it ensures effective protection against abrasion when in contact with the rock.



BLP

DATA





## NOT ADJUSTABLE DYNAMIC LANYARDS

### DYNAPRO

Simple dynamic rope lanyard with sewn termination for work restraint. The dynamic characteristics of this lanyard are far superior to those of a traditional static lanyard.

**Strengths :**

- ▶ Perfectly adapted for work positioning at height.
- ▶ Sewn termination with reinforced eye to protect the rope as well as a PINCH to assist connector orientation.
- ▶ Enhanced level of protection thanks to the use of a dynamic rope.

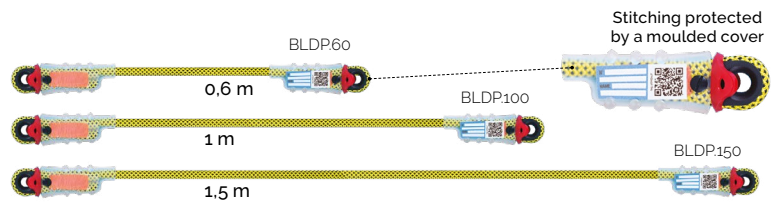

- ▶ Removable cover allows the inspection of termination stitches.
- ▶ Marked with a unique serial number and labelled to accommodate personal markings.

### DYNAPRO 8

Adjustable, dynamic rope lanyard with sewn terminations. The dynamic performance of this lanyard is greatly superior to that of traditional static lanyards. By making your own double fig-8 knot point of attachment to your harness you can obtain an asymmetric 'V' lanyard adjusted to your needs. The lanyard thus made, in conformity with the notice, meets Standard EN 354.

**Strengths :**

- ▶ Possible to clip long or short.
- ▶ Ability to pass intermediate anchors thanks to the 2 branches.
- ▶ Sewn terminations fitted with a sleeve to protect the rope and a pinch to hold the karabiner in position.

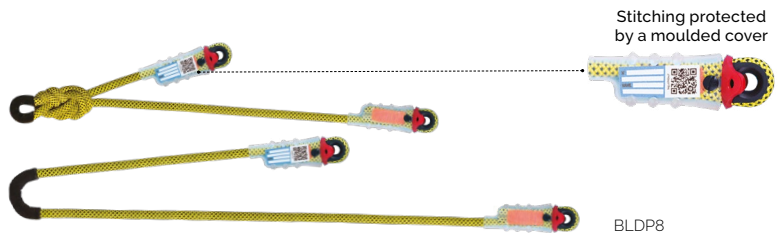

- ▶ Improved security in the event of a fall (even of high factor) on the lanyard because of the use of dynamic rope.
- ▶ Attach with a maillon rapide or directly onto the chest ring.

### DYNAPRO V

Asymmetric 'V' dynamic rope lanyard with sewn terminations. The dynamic performance of this lanyard is greatly superior to that of traditional static lanyards.

**Strengths :**

- ▶ Perfectly adapted to work at height and rescue.
- ▶ Ability to clip-in short or long.
- ▶ Ability to pass intermediate anchors thanks to the 2 branches.
- ▶ Sewn terminations fitted with a sleeve to protect the rope and a pinch to hold the karabiner in position.

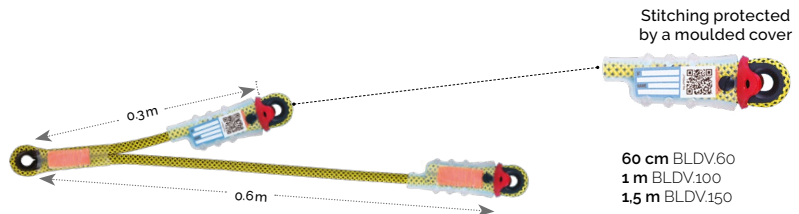

- ▶ Improved security in the event of a fall (even of high factor) on the lanyard because of the use of dynamic rope.
- ▶ Secure with a maillon rapide.

## NOT ADJUSTABLE STATIC LANYARDS

Single or double lanyard with sewn termination for restraint at the workstation or progression on a restraint lifeline. This versatile lanyard allows for temporary anchorages.

**Strengths :**

- ▶ Perfectly suited for working at height.
- ▶ Stitched termination with PINCH to lock the carabiner at its end.
- ▶ The connection to the harness is done by a lark head.
- ▶ Marked with a unique serial number.

### NEXUS I

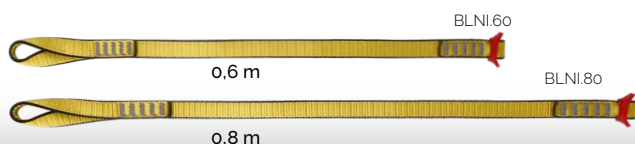

### NEXUS V

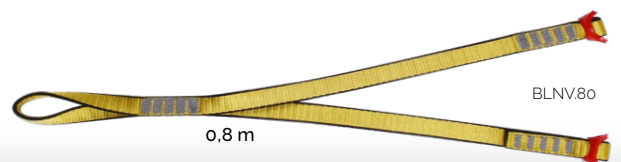



# FALL ARREST LANYARDS

## DYNAPRO-AIR HOOK

Fall arrest lanyard with integrated energy absorber (EN355 + EN 362) designed for work environments with a fall risk.

### Strengths :

- ▶ ABSORB'AIR absorber combined with DYNAPRO lanyard.
- ▶ Supplied with an AIR-HOOK LARGE connector to connect to the anchor point and an O'LIGHT 3-MATIC connector to connect to the harness.
- ▶ Sewn terminations with reinforced eyes to protect the rope.
- ▶ Removable cover allows the inspection of termination stitches.
- ▶ Marked with a unique serial number and equipped with a label to accommodate personal markings.
- ▶ Available in 3 lengths (including connectors and absorber): 1m / 1.5m / 2m.

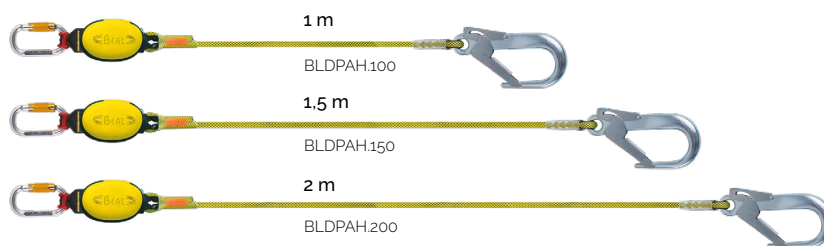

## DYNAPRO-AIR V HOOK

V-shaped fall arrest lanyard with integrated energy absorber (EN355 + EN362). Designed as a progression lanyard for work environments with a fall risk, it is well adapted to structures where anchor points are cables, bars or beams.

### Strengths :

- ▶ ABSORB'AIR absorber combined with a V-shaped lanyard.
- ▶ V-shaped lanyard with two symmetrical rope legs for progression using fall arrest techniques.
- ▶ Supplied with 2 AIR-HOOK LARGE connectors to clip anchor points and an O'LIGHT 3-MATIC connector to connect to the harness.
- ▶ Sewn terminations with reinforced eyes to protect the rope.
- ▶ 2 removable covers allow the inspection of termination stitches.
- ▶ Marked with a unique serial number and equipped with a label to accommodate personal markings.
- ▶ Available in 2 lengths (including connectors and absorber): 1m / 1.5m

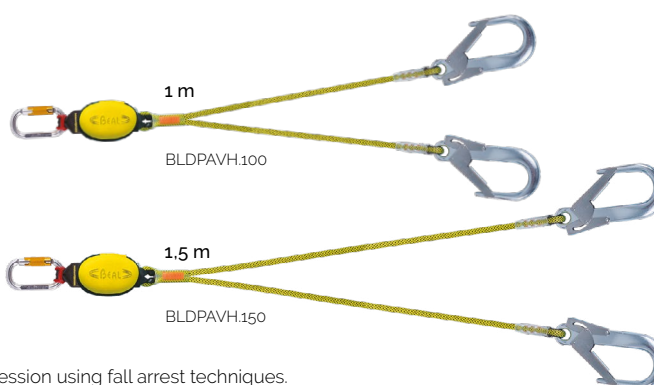

## DYNAPRO-AIR V HOOK XL

V-shaped fall arrest lanyard with integrated energy absorber (EN355 + EN 362). Designed as a progression lanyard for work environments with a fall risk, the size of its connectors make it particularly suited to metal structures.

### Strengths :

- ▶ ABSORB'AIR absorber combined with a V-shaped lanyard.
- ▶ V-shaped lanyard with two symmetrical rope legs for progression using fall arrest techniques. Its 2 two metre legs allow fluid progression on large structures.
- ▶ Supplied with 2 AIR-HOOK XL connectors that can clip anchors on large structures as well as an O'LIGHT 3-MATIC connector to connect to the harness.
- ▶ Sewn terminations with reinforced eyes to protect the rope.
- ▶ 2 removable covers allow the inspection of termination stitches.
- ▶ Marked with a unique serial number and equipped with a label to accommodate personal markings.
- ▶ Available in 1 length (including connector and absorber): 2 m.

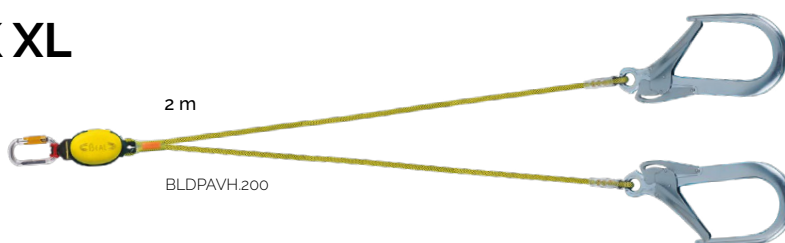

## ABSORB'AIR

Webbing construction energy absorber. Energy is absorbed through the controlled tearing of the webbing's weft during deployment.

### Strengths :

- ▶ Compact and lightweight.
- ▶ Easy to open semi-rigid pouch.
- ▶ Easy to inspect in its entirety.
- ▶ Easy to dry once unrolled.
- ▶ Can be combined with a DYNAPRO lanyard to create a lanyard with energy absorber.
- ▶ Marked with a unique serial number and labelled to accommodate personal markings as.



DATA



DATA

## FALL ARREST HARNESS

### STYX RESCUE / STYX RESCUE JACKET

Lightweight and compact fall arrest harness with two attachment points: 1 sternal and 1 dorsal.

**Strengths :**

- ▶ Different coloured leg loops help distinguish them from the shoulder
- ▶ Straps and so accelerate fitting.
- ▶ The dorsal section contains an area to allow personal marking such as your company's name.



BHPSTR



BHPSTJR

**WITH JACKET**

The dorsal section contains an area to allow personal marking such as your company's name.

### STYX FAST

A very light and compact fall arrest harness with 2 connection points : 1 sternal and 1 dorsal. Quick release buckles to the thighs and a foamed back allow a quick sitting. Versatile because it can be combined with a work position belt.



**Strengths :**

- ▶ Foamed shoulder and back straps for comfort and easy donning.
- ▶ Quick release buckles to the leg loops allows quick fitting.
- ▶ Possibility of adding a work position belt - EN358: STYXBELT.
- ▶ Straps with protection to avoid rubbing at the neck.

- ▶ 2 organiser gear loops to the hips.
- ▶ 2 connector hook loops to the shoulders.
- ▶ Differentiation in color between left and right parts to facilitate the setting up.
- ▶ 2 mini organiser gear loops to attach WORKSTATION accessories.



BHPSTF

### WORKSTATION BELT

#### STYX BELT

Workstation belt. This adjustable belt makes it possible to adjust positioning rings to all morphologies or all situations by a simple sliding. The quick-release buckle offers a simple opening / closing. The belt is compatible with the STYXFAST harness.

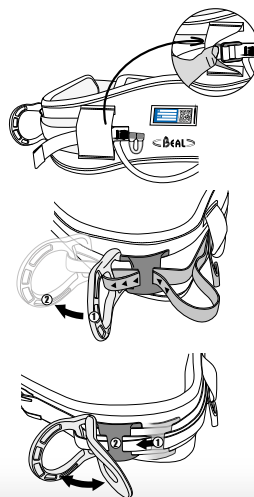

BHPSTB



**Strengths :**

- ▶ Two adjustable aluminum side rings.
- ▶ A wide foamed belt for maximum comfort.
- ▶ A quick buckle at the belt.
- ▶ A large organiser gear loop.
- ▶ Traceability: identification area.
- ▶ 6 mini organiser gear loops to attach WORKSTATION accessories.

# FALL ARREST, ROPE ACCESS AND WORK POSITIONING HARNESS

## SOLACE

Harness for work positioning, suspension and fall arrest.



Solace S : BHPSO.1  
Solace M-L : BHPSO.2  
Solace XL : BHPSO.3

### Comfort :

- ▶ Junction before thighs-adjustable belt for better adaptation to morphology.
- ▶ In the front area, shoulder straps spread out with a clearance at the neck. This clearance is accentuated by the use of narrowed strap.
- ▶ Paddings of sliding thighs along the strap.
- ▶ Rear thigh-belt-adjustable junction.
- ▶ Significant height of the belt with comfort extended on the upper edge, pleasant in suspension.

### Ergonomics :

- ▶ Y-shaped straps to allow for a better positioning of the dorsal attachment point
- ▶ A quick release buckle on one shoulder strap allows for easy fitting without deregulating the harness
- ▶ Two quick release buckles on the leg loops
- ▶ Removable elastic to keep the chest ascender upright on the harness.
- ▶ Easy connection of the shoulder straps at the bottom of the harness thanks to the FLAT LINK connector that can also accommodate the HOLD UP chest ascender.

## SOLACE HOLD UP

Harness for work positioning, suspension and fall arrest perfectly configured for rope access. Very effective at ascending ropes thanks to the low position of the HOLD UP and its parallel orientation to the body.



Solace Hold up S : BHPSO.1  
Solace Hold up M-L : BHPSO.2  
Solace Hold up XL : BHPSO.3

### Traceability :

- ▶ A window at the back of the belt for simplified identification.

### Accessories :

- ▶ On each shoulder there is a reusable fuse loop for storing the connectors of the fall arrest lanyards. In the event of a fall the stored lanyard will release allowing the fall arrest lanyard to uninterruptedly absorb energy.
- ▶ Each shoulder also has passing Velcro to position a fall arrest lanyard or radio.
- ▶ Five equipment loops.
- ▶ Six mini equipment loops to attach WORK STATION accessories.

## OFF SHORE

Integral suspension harness with metal parts made of stainless steel. This harness is equipped with a sternal fall arresting point (EN361), two lateral points (EN358) and a ventral point (EN813) made of textile.

### Strengths :

- ▶ Textile suspension point which allows a great freedom of movement.
- ▶ Quick release stainless steel thigh leg loop buckle for fast fitting.
- ▶ 4 organiser gear loops to the belt.
- ▶ 2 connector hook loops to the shoulders.
- ▶ A knife holder on the shoulder.
- ▶ Traceability: identification area.
- ▶ Mini organiser gear loops for hanging WorkStation accessories.
- ▶ The shoulder strap slides in the sternal ring allowing easy donning.



Off Shore S-M : BHPOFF.1  
Off Shore L-XL : BHPOFF.2



## FALL ARREST, ROPE ACCESS AND WORK POSITIONING HARNESS

### HERO PRO

A fall arrest and work positioning harness.



Hero Pro S : BHPH.1  
Hero Pro M-L : BHPH.2  
Hero Pro XL : BHPH.3



Hero Pro Black S : BHPH.1.BK  
Hero Pro Black M-L : BHPH.2.BK  
Hero Pro Black XL : BHPH.3.BK

### HERO PRO HOLD UP

A fall arrest and work positioning harness with ascender to aid rope ascents.

The harness is equipped with the HOLD UP compact chest ascender that is optimised for ascending ropes. The HOLD UP is designed to stay parallel to the user's body allowing the rope to slide easily through the device, making it particularly user friendly.



Hero Pro Hold up S : BHPHO.1  
Hero Pro Hold up M-L : BHPHO.2  
Hero Pro Hold up XL : BHPHO.3

#### Comfort :

- ▶ X shaped shoulder straps increase comfort and ensure excellent load distribution
- ▶ The padded shoulder straps are held apart to minimise neck chafing.
- ▶ The waist belt's two lateral attachment loops can be folded back to minimise hindrance
- ▶ The dorsal attachment point is made from steel.

- ▶ Two opening quick release buckles (one per leg loop) enable the harness to be easily fitted even with cumbersome footwear.
- ▶ A FLAT LINK connector allows the shoulders straps to be easily connected to the lower part of the harness and is compatible with the HOLD UP chest ascender. Its flat working surface ensures the webbing is properly seated.
- ▶ 4 large, pre-shaped gear loops are positioned around the waist belt to easily accommodate equipment.
- ▶ Mini gear loops compatible with item of the WorkStation.

### AIR SIT

Stable and comfortable suspended work seat for rope access.

#### Strengths :

- ▶ Triangulation of the 2 lateral attachment points assists stability.
- ▶ Durable and breathable comfort padding.
- ▶ 2 plastic lateral gear loops are pre-shaped for ease of clipping.
- ▶ 4 mini gear loops are equally available on the sides to attach 'AIR-LEASH' extendable tool holders or 2 'TOOL-BUCKET' tool pouches.
- ▶ A ring under the seat can be used to attach a bag.



BSAS



# ROPE ACCESS AND WORK POSITIONING HARNESS

## HERO SIT

Work positioning and rope access harness.

### Strengths :

- ▶ The semi-rigid leg loops and waist belt assure optimal pressure distribution where the body is in contact with the harness.
- ▶ The waist belt and leg loops are lined with a breathable foam, increasing comfort and reducing perspiration.
- ▶ The waist belt's two lateral attachment loops are articulated to minimise hindrance.
- ▶ Two double action opening quick release buckles (one per leg loop) enable the harness to be easily fitted even with cumbersome footwear.
- ▶ The rear of the waist belt contains an area to allow personal marking such as your company's name .
- ▶ 3 large, pre-shaped gear loops are positioned around the waist belt to easily accommodate all equipment.
- ▶ 4 mini gear loops can be used to attach 'AIR-LEASH' extendable tool holders or 2 'TOOL-BUCKET' tool pouches.
- ▶ Compatible with the AIR TOP and YPSILON chest harness to create a full body harness EN 361.

Hero sit S : BHPHS.1  
Hero sit M-L : BHPHS.2  
Hero sit XL : BHPHS.3



HERO SIT  
+ AIR TOP

HERO SIT  
+ YPSILON

## SHAOLIN

A lightweight fall arrest and work positioning harness.

### Strengths :

- ▶ This harness benefits from new technology in the PRO range: WEB CORE technology provides exceptional levels of comfort thanks to optimal pressure distribution on hips and thighs. WEB CORE is a wide, thin and lightweight piece of webbing laser cut to the shape of the harness. This results in a more compact, lightweight and above all more comfortable harness.
- ▶ Its ergonomic construction allows a large range of movement.
- ▶ The low position of the ventral attachment point yields maximum progression when ascending ropes, whilst its large diameter provides the space for multiple connection to be made i.e. ascenders, connectors, descender and lanyards.
- ▶ Two ways of attaching equipment:
  - A large ring provides the space for multiple karabiners and lanyards to be connected and accessed easily during a rescue.
  - Two textile attachment points for connecting lanyards metallic devices on both sides of the ring.
- ▶ 2 lateral attachment points EN 358.
- ▶ 1 dorsal attachment point for winching.
- ▶ A handle can be fitted at the back for rescue use.
- ▶ 5 gear organisers, 4 gear loops and 6 fabric loops to connect parts of the WORK STATION range.
- ▶ Replaceable rear elastics on leg loops.
- ▶ Traceability via an identification area.
- ▶ Compatible with the AIR TOP and YPSILON chest harness to create a full body harness EN 361.



Shaolin S : BHPSH.1  
Shaolin M-L : BHPSH.2  
Shaolin XL : BHPSH.3

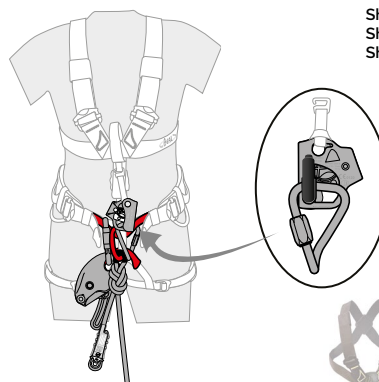

SHAOLIN  
+ AIR TOP

SHAOLIN  
+ YPSILON



DATA



## RESCUE HARNESS

### DRAGON

A lightweight rescue harness. When combined with the DRAGON TOP it can be used for fall arrest and work positioning.

**Strengths :**

- ▶ Padded legloops for good position and comfort
- ▶ Different legloop colour for ease of fitting (left:yellow/right:black)
- ▶ Two textile lateral attachment on the belt for evacuation (EN358)
- ▶ One yellow rear attachment on the belt for evacuation
- ▶ Four gearloops, two straps to hold tools and six mini gearloops compatible with WORKSTATION
- ▶ Compatible with DRAGON TOP to create a full harness



DRAGON  
+ TOP DRAGON

Dragon S-M : BHPD1  
Dragon L-XL : BHPD2

### TRI-ANGEL

Evacuation triangle for vertical rescues.

**Strengths :**

- ▶ Straightforward positioning using 2 adjustable straps.
- ▶ The straps, which are a different colour to the rest of the triangle, assist with both the ease and

speed of deployment of the TRI-ANGEL onto the casualty.

- ▶ The TRI-ANGEL adjusts in size to match the casualty using a webbing positioning scale with 3 settings.
- ▶ Marked with a unique serial number. Includes an area to allow personal marking such as your company's name.



BHPTA

## HARNESS ACCESSORIES

### TOP DRAGON

Lightweight, adjustable Y-shaped torso compatible with DRAGON harnesses for a complete harness. Easy to put on and comfortable, it keeps the operator in an upright position in case of a fall. Two fall arrest attachment points: sternal and dorsal.

**Strengths :**

- ▶ Dorsal attachment point in textile in order to reduce the damage in confined environment
- ▶ Shoulder with narrow part in order to reduce the friction on the neck area
- ▶ Gear loops on each shoulder
- ▶ Dedicated attachment on each shoulder top for a vertical evacuation
- ▶ Webbing to maintain chest ascender in an upright position



BHPTD

### AIR TOP

Adjustable chest harness with figure of 8 shape for use with a HERO SIT or SHAOLIN sit harness. This comfortable harness ensures the user remains in an upright position during a fall.

**Strengths :**

- ▶ Figure of 8 shape provides freedom of movement and distributes pressure around the chest evenly.
- ▶ 2 adjustment buckles to adjust the length of the shoulder straps.
- ▶ A single adjustment buckle allows the sternal attachment point to be correctly positioned in relation to the user, regardless of their physique.
- ▶ A reinforced webbing fall arrest attachment point is ideal in confined spaces allowing progression without hindrance.
- ▶ Can easily be fitted with an elastic positioning strap for the chest ascender.
- ▶ Large elastic retainers help tidy the chest ascender's webbing.

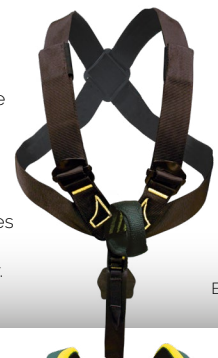

BHAT

### YPSILON

Lightweight and adjustable Y-shaped chest harness compatible with HERO SIT and SHAOLIN sit harnesses. Comfortable and easy to fit, it ensures the user remains in an upright position during a fall.

**Strengths :**

- ▶ Lightweight
- ▶ Adjustments are made using a front buckle at shoulder height and a dorsal rear buckle.
- ▶ The shoulder strap slides through the sternal D-ring which provides a large range of movement and ensures ease of fitting.
- ▶ A slight narrowing of the shoulder straps prevents chafing around the neck.
- ▶ Multiple attachment points for the elasticated chest ascender retainer.
- ▶ Two reinforced loops per shoulder strap can be used to attach scaffolding hooks.



BHPY

## QUANTUM



Light helmet featuring an ABS shell with a polystyrene liner for optimal energy absorption in case of impact. Its chinstrap opens between 15 and 25 daN in order to avoid strangulation. Certified EN 397.



BKPOW

BKPOY

BKPOO

### Strong points :

- Very good ventilation thanks to its 6 openings. The position and the shape of the opening prevent from letting the water in.
- Its setting up is extremely easy and user friendly.
- 2 different systems to use a headlamp :
  - 4 hooks to attach the headlamp's band
  - 2 dedicated slots (1 in the front, 1 in the back) to slide in the headlamp.
- Certified against lateral deformation and low temperature: -40°C.

### Compatible accessories :

- Visor (QUANTUM VISOR) and visor protection (QUANTUM V PROTECT).
- Card holder (QUANTUM CARD HOLDER) that can be slide in the slots at the front and the back.
- Neck protection (QUANTUM NECK PROTECT).
- Reflective Stickers (QUANTUM STICKERS).

## QUANTUM ELEC



Light helmet featuring an ABS shell with a polystyrene liner for optimal energy absorption in case of impact. Its chinstrap opens between 15 and 25 daN in order to avoid strangulation. Certified EN 397 and EN 50365 against electrical hazards.

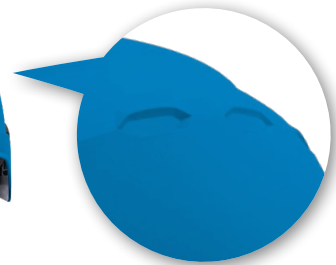

BKPOE

### Strong points :

- Its setting up is extremely easy and user friendly.
- 2 different systems to use a headlamp :
  - 4 hooks to attach the headlamp's band
  - 2 dedicated slots (1 in the front, 1 in the back) to slide in the headlamp.
- Certified against lateral deformation and low temperature: -40°C.

### Compatible accessories :

- Visor (QUANTUM VISOR) and visor protection (QUANTUM V PROTECT).
- Card holder (QUANTUM CARD HOLDER) that can be slide in the slots at the front and the back.
- Neck protection (QUANTUM NECK PROTECT).
- Reflective Stickers (QUANTUM STICKERS).

## QUANTUM VISOR

Eye visor compatible with QUANTUM and QUANTUM ELEC helmets. This visor can be protected from scratches with a visor protector.



BKPOVS

## QUANTUM V PROTECT

Visor protector, compatible with QUANTUM VISOR for QUANTUM and QUANTUM ELEC helmets. Avoids the visor from scratching when it is not in use.



BKPOVP

## QUANTUM NECK PROTECT

Textile neck protector compatible with QUANTUM and QUANTUM ELEC helmets. Its covering shape protects from the sun and rain.

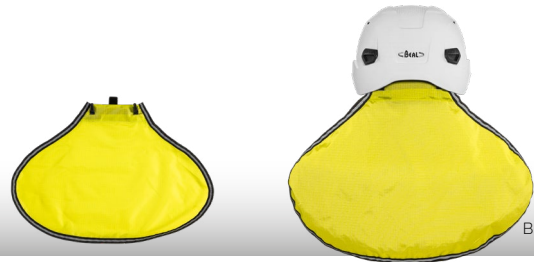

BKPONP

## QUANTUM STICKERS

Reflective Stickers.



BKPOS

## QUANTUM CARD HOLDER



BKPOC

DATA





DATA



## O'LIGHT

BMCLOL



Symmetrical aluminium oval shaped connector for use with equipment with swivelling side plates such as pulleys, rope clamps, mobile fall arrest devices, etc..

## O'LIGHT 3 MATIC

BMCLOL3



Symmetrical aluminium oval shaped connector for use with equipment with swivelling side plates such as pulleys, rope clamps, mobile fall arrest devices, etc..

## BE QUICK

BMCLBQ.col



Carabiner particularly suitable for frequent use as it is easy and quick to lock and unlock. It is very effective during repetitions of maneuvers on anchor. Colours: Blue (B), Green (G), Orange (O)

## BE LINK

BMCLBLN



Asymmetrical aluminium connector for lanyards or for use with belay devices. The asymmetrical shape helps to guide the device towards the connector's apex.

## BE LINK BI MATIC

BMCLBLN2



Asymmetrical aluminium connector for lanyards or for use with belay devices. The asymmetrical shape helps to guide the device towards the connector's apex.

## BE LINK 3 MATIC

BMCLBLN3



Asymmetrical aluminium connector for lanyards or for use with belay devices. The asymmetrical shape helps to guide the device towards the connector's apex.

## BE LOCK

BMCLBL



Symmetrical aluminium screw gate connector with large capacity and opening to accommodate multiple items. Its generous loading surface and HMS shape facilitate its use with Clove and Italian hitches.

## BE LOCK 3 MATIC

BMCLBL3



Symmetrical aluminium screw gate connector with large capacity and opening to accommodate multiple items. Its generous loading surface and HMS shape facilitate its use with Clove and Italian hitches.

## FLAT LINK 3 MATIC

BMCLFL



Symmetrical, trapezoidal shaped aluminium karabiner designed to connect the top and bottom parts of a full body harness. Its flat working surface ensures the webbing is properly seated. The FLAT LINK was designed to be compatible with the HOLD UP chest ascender.

## O'SMITH

BMCLOS



Symmetrical oval shaped steel connector.

## O'SMITH 3 MATIC

BMCLOS3



Symmetrical oval shaped steel connector.

## AIR-SMITH

BMCLAS



High capacity asymmetrical steel connector with large opening to assist with connections to metal anchors. Its capacity allows it to accommodate multiple items.

## AIR-SMITH 3 MATIC

BMCLAS3



High capacity asymmetrical steel connector with large opening to assist with connections to metal anchors. Its capacity allows it to accommodate multiple items.

## QUICK LINKS



- |   |                             |                 |
|---|-----------------------------|-----------------|
| 1 | STANDARD GALVA 8 mm         | <b>BMMNZ08</b>  |
| 2 | STANDARD GALVA 10 mm        | <b>BMMNZ10</b>  |
| 3 | LONG OPENING GALVA 7 mm     | <b>BMMGOZ07</b> |
| 4 | PEAR GALVA 10 mm            | <b>BMPMPZ10</b> |
| 5 | DELTA GALVA 8 mm            | <b>BMMDZ08</b>  |
| 6 | DELTA GALVA 10 mm           | <b>BMMDZ10</b>  |
| 7 | MAILLON SEMI CIRCULAR 10 mm | <b>BMMSCZ10</b> |
| 8 | DELTA TWIST 9 mm            | <b>BMMDTZ09</b> |

## AIR-HOOK LARGE

Auto-locking aluminium connector with large opening. Ideal for connections to cables, bars and beams.



BMC60

## AIR-HOOK XL

Auto-locking aluminium connector with very large opening.



BMC110

## RIGGING PLATES AND SWIVEL

### AIR-PORT 4

Aluminium rigging plate which can accommodate 4 connectors.

**Strengths :**

- ▶ 20 mm holes allow connectors with locking barrels to be inverted easily.
- ▶ Individual serial number.



BMAP4

### AIR-PORT 8

Aluminium rigging plate which can accommodate 8 connectors.

**Strengths :**

- ▶ 20 mm holes allow connectors with locking barrels to be inverted easily.
- ▶ Individual serial number.



BMAP8

### TWIST'AIR B

Compact aluminium swivel with ball bearings to optimise performance even when loaded.

**Strengths :**

- ▶ Individual serial number.
- ▶ Ball Bearings.



BMSW

## PULLEYS

### TRANSF'AIR 1

Large single pulley with swivelling side plate. Stainless steel axle and washer. The sheave is mounted onto a bronze collar to promote a good level of efficiency. Maximum  $\varnothing \leq 16$  mm.

BMP1



### TRANSF'AIR 1B

Highly efficient single pulley with swivelling side plate and ball bearing mounted sheave. Its swivelling action allows the pulley to be positioned anywhere along the rope, whilst the ball bearings ensure maximum efficiency and durability. Ideal for intensive use with large rope diameters. Stainless steel axle and washers.

BMP1B



### TRANSF'AIR 2

Large double pulley with swivelling side plate well suited for use in pulley systems. Stainless steel axle and washer. The sheave is mounted onto a bronze collar to promote a good level of efficiency. Maximum  $\varnothing \leq 16$  mm.

BMP2



### TRANSF'AIR 2B

Highly efficient double pulley with swivelling side plates thanks to a ball bearing mounted sheave. Its swivelling action allows the pulley to be positioned anywhere along the rope, whilst the ball bearings ensure maximum efficiency and durability. Ideal for intensive use with large ropes diameters. Stainless steel axle and washers.

BMP2B



### TRANSF'AIR MINI

Compact and lightweight pulley with swivelling side plate. Stainless steel axle and washer. The sheave is mounted onto a bronze collar to promote a good level of efficiency. Maximum  $\varnothing \leq 11$  mm.

BMPMINI



### TRANSF'AIR FIXE

Compact and lightweight pulley with fixed side plates. Stainless steel axle and washer. The sheave is mounted onto a bronze collar to promote a good level of efficiency. Maximum  $\varnothing \leq 12$  mm.

BMPF



### TRANSF'AIR FIXE B

Pulley with fixed side plates and ball bearings for optimal efficiency. Its compact and lightweight nature make it easy to handle. Allows a pulley system to be set up by adding a component such as an ascender. Maximum  $\varnothing \max \leq 13$  mm.

BMPFB



### TRANSF'AIR TWIN B

A double pulley with two inline stainless steel sheaves mounted on ball bearings. The TRANSF'AIR Twin B is specifically designed for intensive use on rope or wire zip lines.

BMPTB



DATA



DATA

## AIR STOP

Auto-block descender with anti panic function for a single rope.

### Strengths :

- ▶ Maximum working load of 130 kg with 9 mm rope, and up to 200 kg with ropes from 10 to 12 mm.
- ▶ Anti-panic function with 2 blocking positions.
- ▶ The maximum authorised speed of descent is 2 m/s.
- ▶ Useable on a wide spread of rope diameters from 9 to 12 mm (EN12841-C).
- ▶ Long control lever for a more progressive feel.
- ▶ Rope can be inserted into device without unclipping it.
- ▶ Unique serial number.

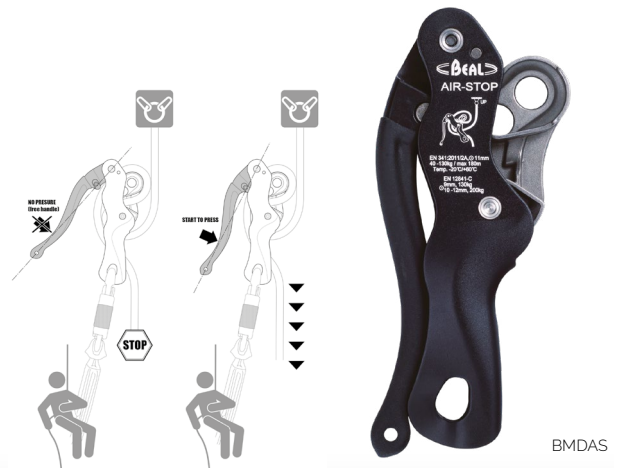

BMDAS

## AIR FORCE 8

Classic, robust and easy to use belay device.

It is compatible with a large range of rope diameters whether single, double or twin.

The friction can easily be varied whatever the condition of the ropes (frozen, wet, different diameters..).



BMDAF8

## MONITOR

Aluminium mobile fall arrest device with swivelling side plate.

### Strengths :

- ▶ Mobile fall arrest device with camming action. Cam function reduces abrasion to the rope when activated.
- ▶ Meets the requirements of the following standards: EN 353-2, EN 12841-A 100 Kg diameter 11-13 mm (EN1891).
- ▶ Rescue : maximum 200 kg,  $\varnothing$ 11-13 mm.
- ▶ Swivelling side plate allows for ease of installation on the rope.
- ▶ A lateral brake converts the MONITOR into a rope clamp for work positioning.
- ▶ Easily locks as a result of a fall.
- ▶ Easily follows the operator both during ascent and descent.
- ▶ Marked with a unique serial number.
- ▶ The MONITOR can be complimented with a MOBILE-LANYARD and its 2 attachment points.



BMFAM

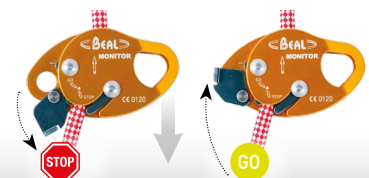



## MOBILE-LANYARD

Lanyard with 2 attachment points. The MOBILE-LANYARD is certified to work with the MONITOR mobile fall arrest device, enabling it to be positioned away from the operator.

Allows the operator to create a short or longer link dependant on their needs: Short link for work on a gentle slope or to limit the length of a fall (20 cm).

Longer link to distance the rope from the operator and to gain freedom of movement (40 cm).

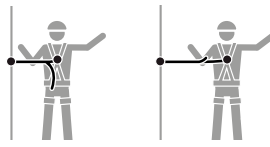

BFAL

### Strengths :

- › Includes two PINCH's to ensure the correct orientation of the connector at its extremity.
- › Marked with a unique serial number.

## AIR-KIT 11mm

Specific kit to create a mobile fall arrest system (EN 353-2 and EN12841-A 100 Kg) especially adapted to vertical work or work on inclined surfaces.

### Kit includes :

- › A MONITOR mobile fall arrest device.
- › A MOBILE-LANYARD with 2 positions: 20 cm and 40 cm.
- › 2 O'LIGHT 3-MATIC connectors to attach the lanyard to both the MONITOR and the harness.
- › Connectors: two O'LIGHT 3-MATIC and one BE LOCK 3-MATIC.
- › A length of rope 10 m / 15 m / 20 m / 30 m / 50 m / 60 m with a
- › 11 mm diameter with sewn termination protected by a reinforced eye.
- › 1 BE-LOCK 3-MATIC connector to attach the rope to the anchor point.

### Strengths :

- › Removable cover allows the inspection of termination stitches
- › Products marked with a unique serial number and equipped with a label to accommodate personal markings.
- › Each length is represented by a colour for quick and efficient identification of both its length and diameter.

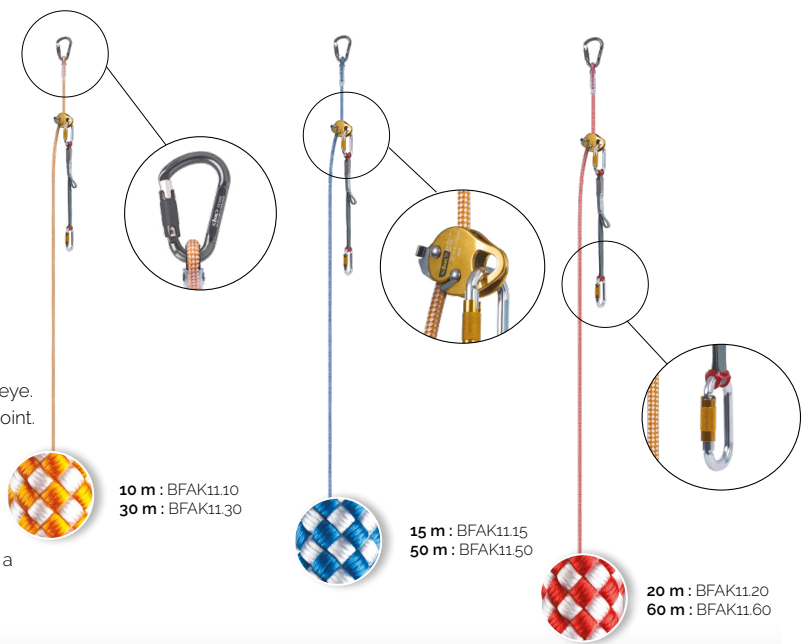

## SOFT AIR KIT

100% textile fall protection kit developed for work on fragile surfaces in a vertical or inclined environment.

### Pre-assembled kit including :

- › a 10m rope length, 11mm in diameter with two sewn terminated rope endings.
- › an 8mm VOLCANO Prusik acting as a rope clamp.
- › one BE LOCK 3MATIC karabiner to connect the rope to the anchor point.
- › one O'LIGHT 3MATIC to connect to the harness.

### Strengths :

- › Textile rope clamp protects sensitive surfaces from damage (roofs, solar panels, glass surfaces, etc.).
- › The self-locking prusik works in both directions.

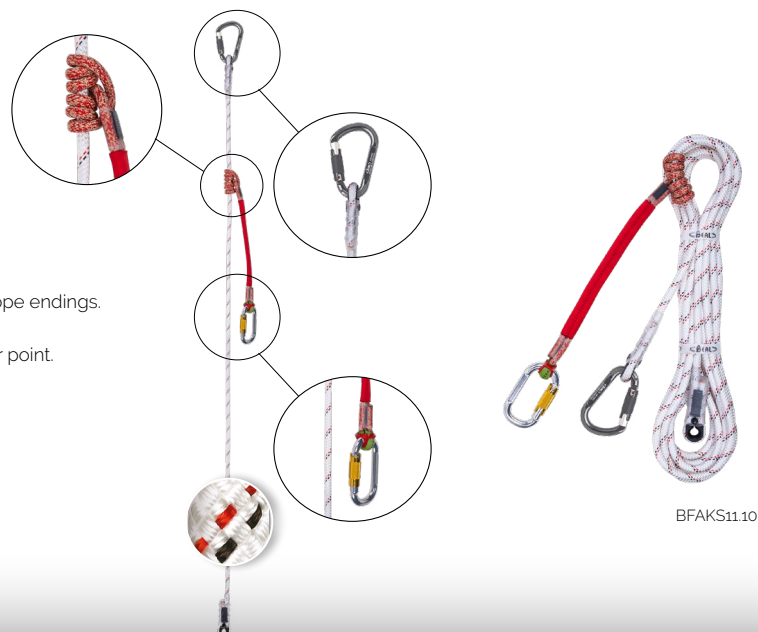

DATA



DATA

## HANDS UP

Handled ascender with ergonomic design to aid rope ascents with one or two hands.

### Strengths :

- ▶ Can be used to compliment the HOLD UP chest ascender or any other ascender for rope ascents
- ▶ Large lower attachment hole easily accommodates the connector for the AIR STEP foot loop.
- ▶ The ascender's shape allows it to be held with two hands when ascending rope: one on the side beneath the trigger and one above it.
- ▶ The handle is reinforced to improve ergonomics and comfort.
- ▶ Large lower attachment hole can accommodate multiple karabiners and maillons.
- ▶ All-metal construction of the operating mechanism to increase durability
- ▶ An ergonomic protruding lever facilitates cam operation.

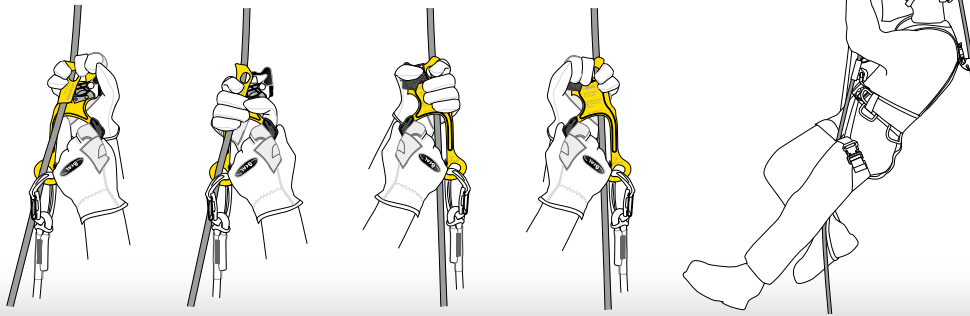

BMBHAR

## HOLD UP

A compact ventral ascender for ascending ropes

### Strengths :

- ▶ The attachment hole protrudes from the ascender's body at a 90 degree angle. This ensures the device remains both upright and parallel to the user's body and allows the rope to easily slide through the device.
- ▶ Positioned low on the harness to maximise progression with every move.
- ▶ All-metal construction of the operating mechanism to increase durability.
- ▶ An ergonomic protruding lever facilitates cam operation.
- ▶ Compatible with all PRO harnesses through the use of a FLAT LINK connector, which connects the harness to the ascender.



BMBHO

## TRACT UP

Compact emergency rope clamps

Compatibility - 8 in 11mm  
 Charge with maximal use in mode blocker: 2,5kN  
 Breaking load in mode blocker: 4kN  
 Materials: aluminum, stainless steel and silicone.

Duration of storage - 5 years  
 Operating life - 10 years



### Strengths :

- ▶ Allows the recovery and the lifting of light loads
- ▶ Blocker of useful repair during laborers(operations) of mouflage and help
- ▶ In help: back up line glide in 250 kg

BMTR

## AIR-STEP

Adjustable footloop with quick adjusting system around the foot for ascending fixed ropes with an ascender.

### Strengths :

- ▶ Quick adjusting system with ON / OFF function. In the ON position, the user's foot stays locked in the footloop. In the OFF position, the adjustment system does not engage, meaning the user's foot is not locked.
- ▶ A large buckle facilitates adjustments of the footloop, even when wearing gloves.
- ▶ A stiffener in the loop helps to place a foot inside it.
- ▶ Reinforced with webbing to help protect against abrasion.

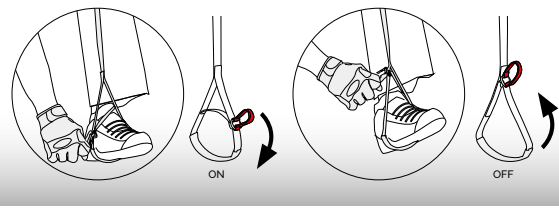

BSTEP

## PRO RESCUE 40

Rescue bag ideal for rapid access operations. Capable of taking 30 metres 12.5 mm of rope and basic hardware.

Capacity	Weight	Height	Width
40 L	900 g	60 cm	30 cm



BMBH BSAC.PR40 AR

## PRO RESCUE 60

Rescue bag ideal for rapid access operations. Capable of taking 60 metres 12.5 mm of rope and basic hardware.

Capacity	Weight	Height	Width
60 L	1000 g	60 cm	35 cm



BSAC.PR60

## PRO WORK 35 CONTRACT

35 litre transport bag – simple and effective.

Capacity	Weight	Height	Width
35 L	735 g	70 cm	30 cm



BSAC.PW35C

## PRO WORK 35

35 litre ergonomic transport bag including a waterproof external pocket.

Capacity	Weight	Height	Width
35 L	1080 g	70 cm	30 cm



BSAC.PW35

## PRO WORK 45

Large 45 litre capacity transport bag specially adapted to heavy load carrying. A comfortable belt complements the ergonomic shoulder straps and a padded back. Waterproof exterior pocket and large under-lid pocket to cater for smaller personal items as well as lifetime record sheets. A transparent window aids in identification.

Capacity	Weight	Height	Width
45 L	1525 g	78 cm	30 cm



BSAC.PW45

## PRO WORK 60

Very large 60 litre capacity transport bag with wide, stiff opening well adapted to rescue and large volume carrying requirements. A large waterproof transparent window allows you to see the sac contents. 2 very strong carrying handles help with handling heavy loads.

Capacity	Weight	Height	Width
60 L	1825 g	75 cm	35 cm



BSAC.PW60

## COMBI PRO 40

Bag for professionals who require quick and easy access to their kit.



Capacity	Weight	Height	Width
38 L	1960 g	72 cm	21 cm



BSAC.CP40.BK

## COMBI PRO 80

Bag for professionals who require a large volume, yet maintaining quick and easy access to their kit.



Capacity	Weight	Height	Width
45 L	2500 g	72 cm	26 cm



BSAC.CP80.BK

DATA

--	--	--	--



DATA

## GENIUS SIMPLE & TRIPLE

Bags for carrying small tools and fastenings.  
The clic clac express closure stops the pocket contents getting lost.  
A magnetic plate allows temporary storage on the outside of the pocket.  
Available as a single pocket and an assembly of 3 with external tool carriers.

### Strengths :

- ▶ Express closure.
- ▶ Easy to attach to the harness.
- ▶ Rigid opening.
- ▶ Magnetic plate.

	Capacity	Weight	Height	Width	Max. load
Simple	1.5 L	180 g	25 cm	15 cm	50 kg
Triple	4.5 L	560 g	75 cm	45 cm	150 kg



## GENIUS BUCKET

A 20 litre bucket for carrying tools as well as small screws and fittings thanks to the 3 GENIUS CLIC CLAC pockets attached to the inside.  
The large opening with stiffener allows easy access to its contents.

### Strengths :

- ▶ Easy, convenient access to tools.
- ▶ CLIC CLAC pocket closure system.
- ▶ Rigid carrying handle, with a minimum breaking load of 100kg
- ▶ Waterproof pocket.
- ▶ Reinforced base.

Capacity	Weight	Height	Width	Max. load
20 L	1085 g	40 cm	40 cm	50 kg



## GENIUS TOOL BUCKET

A rigid 20 litre bucket for power tools such as a hammer drill, electric screwdriver or angle grinder; constructed with a clever 'twist and fold' function to reduce size for storage. Small gear loops on the outside and inside edges of the bag can be used to attach small CLIC CLAC pockets (TOOL BUCKET, GLASS BUCKET, LONG TOOL BUCKET) to organise your work station as you wish.

### Strengths :

- ▶ Easy, convenient access to tools
- ▶ Additional BUCKETs can be added
- ▶ Rigid carrying handle with a minimum breaking load of 100kg
- ▶ 'twist and fold' function to reduce size for storage
- ▶ Comfortable and adjustable shoulder strap helps to carry the bucket
- ▶ Waterproof pocket
- ▶ Reinforced base

Capacity	Weight	Height	Width	Max. load
20 L	1085 g	40 cm	40 cm	50 kg



## BUCKET HAT

A removable lid for the GENIUS BUCKET PLUS. Designed to protect items inside the GENIUS BUCKET PLUS from bad weather, dust etc. and to restrain the contents during transit and whilst hauling.

Fitted using clips.





## GLASS BUCKET

A small transparent bucket for organising bolts, screws and other small items whilst leaving contents easily visible.

The CLIC CLAC system can be used to quickly close the bag and prevents loss of contents during transport.

2 external mini karabiners are fitted to connect the GLASS BUCKET to the GENIUS BUCKET, HERO PRO, SYNCRO and STYX harness or to the AIR-SIT work seat.

Capacity	Weight	Height	Width
1,8 L	115 g	14 cm	16 cm



BSAC.GLB

## TOOL BUCKET / TOOL BUCKET L

Medium size tool organiser bucket.

The CLIC CLAC system can be used to quickly close the bag and prevents loss of contents during transport.

Two mini external gear loops can be used to connect the BEAL AIR-LEASH extendable gear holder. Two external mini karabiners can be used to connect the TOOL-BUCKET either to the HERO PRO, SYNCRO and STYX harness or to the AIR-SIT work seat.

	Capacity	Weight	Height	Width
Tool Bucket	3,4 L	180 g	25 cm	16 cm
Tool Bucket L	5 L	215 g	35 cm	16 cm



BSAC.TB

BSAC.TBL

## TOOL BELT

A waist belt with small gear loops for use with the TOOL BUCKET, LONG TOOL BUCKET, GLASS BUCKET, AIR LEASH and ATTRAC'TOOL.

Webbing gear loops positioned around the belt allow the tools to be secured where convenient. The belt is reinforced to help spread out the weight of the tools on the waist.

Mini waist measurement	Maxi waist measurement	Width	Weight
70 mm	130 mm	50 mm	190 g



BATB

## ATTRAC'TOOL

A magnetic plate that allows you to temporarily attach a leash secured tool to an appropriate metal surface.

The ATTRAC'TOOL can be fixed to a belt or shoulder strap of the HERO PRO harness or to the small gear loops of a harness, BUCKET or TOOL BELT.

When fitted to a harness' waist belt, a strap can be clipped around the thigh to stop the magnet from lifting up when picking up the tool. The strap can also be used to hang the ATTRAC'TOOL from a railing.

The ATTRAC'TOOL is modular and can be positioned both vertically and horizontally depending on the tools used and the working environment.



BAAT

## AIR LEASH

An extendable gear loop allowing tools to remain attached whilst in use.

Minimum length	Weight	Max length with 500g load	Max. load
45 cm	55 g	150 cm	500 g

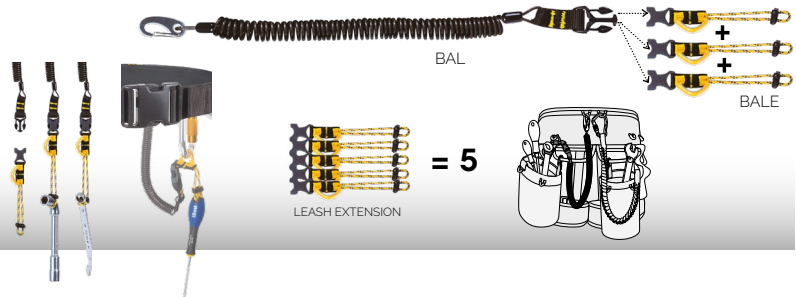

BAL

BALE

LEASH EXTENSION = 5

LEASH EXTENSION

## SUPER LEASH

A webbing based extendable gear loop allowing tools to remain attached whilst in use.

One end can be used to attach tools by means of a girth hitch or slipknot (it is important you select an attachment method appropriate for the specific tool). The other end is equipped with a screwgate mini-karabiner for attachment to a tool pouch or gear loop.

Minimum length	Weight	Max length with 10kg load	Max. load
70 cm	70 g	115 cm	10 kg

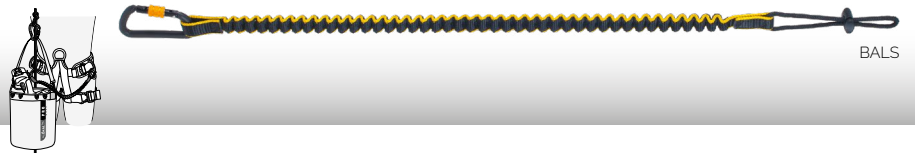

BALS

DATA

## FALL ARREST KIT 10 m STYX

A complete pre-assembled solution to protect against falls from height, it includes :

- A Mobile Fall Arrest device, called the Monitor, which comes with a block mode.
- A Mobile-Lanyard for the MONITOR with the option of 2-positions: 20 cm and 40 cm.
- 2 x O'Light 3 Matic karabiners to connect the mobile-lanyard: on one end to the Monitor, on the other end to the harness.
- 1 Be Lock 3 Matic karabiner to connect the rope to the anchor.
- A 10-metre 11mm Industry rope with a sewn termination in the rope end.
- A light STYX fall arrest harness with 2 attachment points: 1 sternal and 1 dorsal.
- A carry bag.



BSAC.BH

## FALL ARREST KIT 10 m STYX FAST

A complete pre-assembled solution to protect against falls from height, it includes :

- A Mobile Fall Arrest device, called the Monitor, which comes with a block mode.
- A Mobile-Lanyard for the MONITOR with the option of 2-positions: 20 cm and 40 cm.
- 2 x O'Light 3 Matic karabiners to connect the mobile-lanyard: on one end to the Monitor, on the other end to the harness.
- 1 Be Lock 3 Matic karabiner to connect the rope to the anchor.
- A 10-metre 11mm UNICORE Access rope with a sewn termination in the rope end .
- A light STYX FAST fall arrest harness with 2 attachment points: 1 sternal and 1 dorsal.
- Quick release buckles on the leg loops and a padded back allow for quick fitting.
- A carry bag.



BSAC.BH

## PROTECTOR

A rope can wear very rapidly over a sharp edge. To protect it, use the PROTECTOR, an ultra-solid rope protector made of two layers of coated material.



70 cm

150 g

BPR70

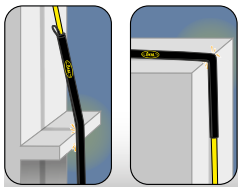

## MAGNETIC PROTECTOR

Rope protector reinforced on both sides by a tape for better abrasion resistance. Installation facilitated by a magnetic closure.



70 cm

260 g

BPRM



## HOT PROTECTOR

Made of glass fibre and aluminium, the HOT PROTECTOR is a patented rope protector resistant to heat, welding spatter, angle grinder, or a blowlamp flame - for a short time. Placement is facilitated by a magnetic closure.



70 cm

180 g

BPRH

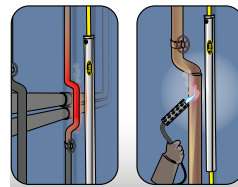

## ROPE DEFENDER

Flexible sleeve made from coiled steel which serves to protect ropes from sharp edges. Thanks to its flexibility, it adapts to all angles. The spirals that are in contact with the edge squeeze together under the rope's movement therefore ensuring total protection. The steel sleeve is virtually indestructible. Its reinforced rubber protecting cover exists as a separate part and may be easily replaced.



50 cm

730 g

BPRD

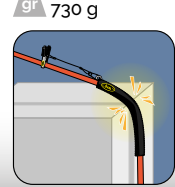

## EDGE GUARD

Rope protector in stainless steel to protect a rope moving over a sharp edge.

**Strengths :**

- ▶ Modulable - can be linked together with maillon rapides.
- ▶ Secure with 2 cords (supplied).
- ▶ 2 side plates prevent the rope from leaving the rail.



300 g

BPREG

# HEADLAMPS

## FF120



A headlamp with 2 surprisingly powerful light sources in relation to its size: 120 lumens in maximum mode with an 120 m throw yet weighing in at only 96 g. «Continuous Power» in Medium mode.

## FF210 R



A powerful rechargeable headtorch able to simultaneously provide both close proximity lighting as well as long distance lighting. Its two buttons allow a second light source to be switched on and off independently whilst maintaining the first. The torch can be recharged using USB but equally works with AAA batteries. The FF210R uses Continuous Power for all its settings when used with the rechargeable battery.

# ACCESSORIES

## ROPE CUTTER



## ROPE BRUSH

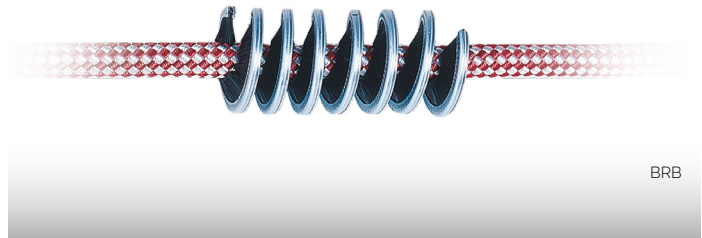

## ROPE TAPE

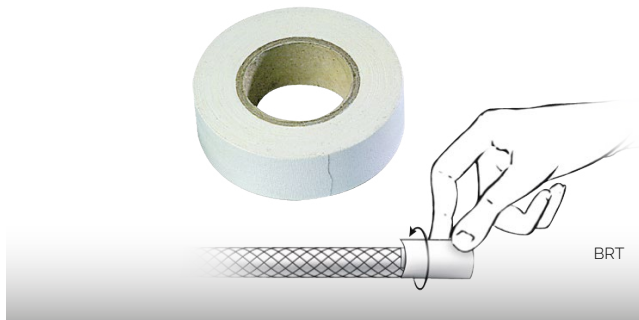

## NFC CHIPS



## MARKING TICKET KIT



## MARKING TICKET KIT XL

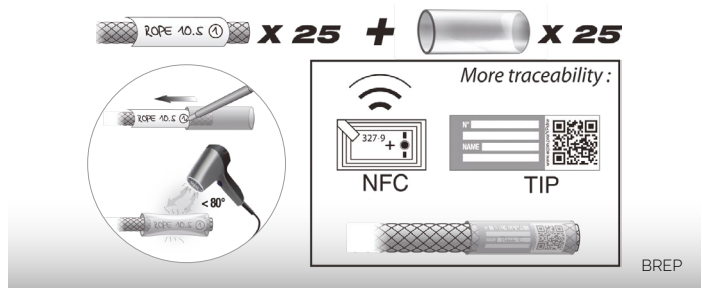

DATA







## BEAL

2, rue Rabelais - 38200 Vienne - FRANCE  
Tel: +33 (0)4 74 78 88 88 - Fax: +33 (0)4 74 85 27 76

[commercial@beal-planet.com](mailto:commercial@beal-planet.com)  
[www.beal-planet.com](http://www.beal-planet.com)

Non-contractual images. Drawing reserved for the exclusive use of BEAL.

Copyrights photos: ©Cyril Crespeau, ©Kyrre Buxrud, Hoyden AS,  
123rf ©Georg Henrik Lehnerer, ©Keng Po Leung, ©narathip12, ©federicofoto  
©Maxime GUIGUE @MADMAX studio,  
Photos Products: ©Cyril Crespeau, ©Maxime GUIGUE @MADMAX studio,  
Design: MADMAX studio.

Edited 10/2022.